

Veneer Occasional Tables

GSA NOT ON CONTRACT

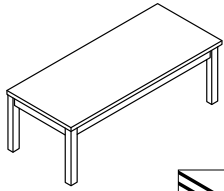







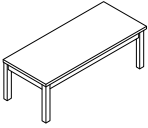

► 5190 Series Tables feature hardwood veneer tops and solid wood legs.

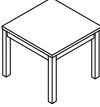
Veneer Occasional Tables are available in the following finishes:
 Bourbon Cherry (H)
 Henna Cherry (J)
 Mahogany (N)
 Medium Oak (M)

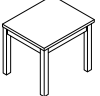
► Meets or exceeds ANSI/BIFMA and ISTA performance standards.



	Description	Model	Ship Weight	Cube	List
 NOC	Coffee Table 48"L x 20"W x 16"H E  A	5191	44 	3.0	\$ 445
 NOC	Corner Table 24"L x 24"W x 20"H E  A	5192	22 	1.4	\$ 360
 NOC	Straight Table 24"L x 20"W x 20"H E  A	5193	20 	1.4	\$ 348

E  A Easy to assemble.
 Shippable by small-package carrier.

SPECIFY: Model.Finish

EXAMPLE: 5191.NN

index accessories education storage & files seating systems desking tables

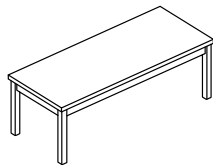

▶ Durable material and construction make laminate occasional tables ideal for high traffic areas such as lobbies, reception rooms and lounges. Versatile design is also well suited to private offices.

▶ Coffee, Corner and End Tables feature top-over-apron styling with square corner detail, which complements many interiors and furniture designs, including the 10500 Series.
▶ Tables accommodate lamps, magazines, telephones, plants, laptops and more.

▶ Tops and aprons are abrasion- and stain-resistant, thermal-fused laminate over 1 1/8" thick solid core high-performance particleboard.
▶ Cylinder and cube tables have recessed black plinth base with tack glides. Tops and sides are covered with premium high pressure laminate.

▶ Meets or exceeds ANSI/BIFMA and ISTA performance standards.

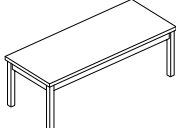
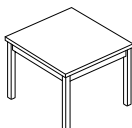
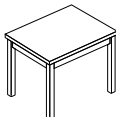
	Description	Model	Ship Weight	Cube	List
 E A	Coffee Table 48"L x 20"W x 16"H	80191	48 [S]	3.4	\$ 347
 E A	Corner Table 24"L x 24"W x 20"H	80192	35 [S]	2.1	\$ 299
 E A	End Table 24"L x 20"W x 20"H	80193	29 [S]	1.8	\$ 284

Laminate Occasional Tables (80191, 80192 and 80193)

Woodgrain: Bourbon Cherry (H), Columbian Walnut (Z), Henna Cherry (J), Mahogany (N), Medium Oak (M), Natural Maple (D), Shaker Cherry (F).

Solid: Black (P), Charcoal (S)

Patterned: Bronze Legacy (L3*), Carbon Evolv (L1*), Grey Tigris (L6*).

* Select edge/apron/leg color — Black (P), Bourbon Cherry (H), Charcoal (S), Henna Cherry (J), Mahogany (N), Medium Oak (M) or Natural Maple (D).

Two-Tone: Black/Charcoal (PS), Bourbon Cherry/Black (HP), Bourbon Cherry/Charcoal (HS), Charcoal/Black (SP), Columbian Walnut/Black (ZP), Columbian Walnut/Charcoal (ZS), Henna Cherry/Black (JP), Henna Cherry/Charcoal (JS), Mahogany/Black (NP), Mahogany/Charcoal (NS), Medium Oak/Black (MP), Medium Oak/Charcoal (MS), Natural Maple/Black (DP), Natural Maple/Charcoal (DS), Shaker Cherry/Black (FP), Shaker Cherry/Charcoal (FS).

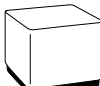
	Cylinder Table 20" Diameter x 20"H	80170	40	6.2	\$ 469
	Cube Table 24"L x 24"D x 20"H	80180	55	8.6	\$ 469

Laminate Occasional Tables (80170 and 80180)

Woodgrain: Bourbon Cherry (H), Henna Cherry (J), Mahogany (N), Medium Oak (M), Natural Maple (D).

E A Easy to assemble.
S Shippable by small-package carrier.

Veneer Conference Tables — Tops

GSA SIN 711-11 Type 2/3

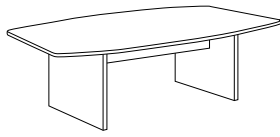

- ▶ Available in four top styles and six base styles.
- ▶ See chart below to determine base configuration requirements for selected top size.
- ▶ Square edge is suitable for use with transitional and contemporary casegoods and seating.
- ▶ Bases and tops ordered separately and shipped in separate cartons.
- ▶ Tables are easy to assemble.
- ▶ All bases feature adjustable leveling glides.
- ▶ Slab bases feature longitudinal brace in matching finish.
- ▶ Table with bases are 29½"H and have a 1½" edge profile.
- ▶ Catalyzed lacquer finish.
- ▶ Slipped match veneers with multi-step process.
- ▶ More veneer conference tables on page 34.
- ▶ HON Conference Tables meet or exceed ANSI/BIFMA and ISTA performance standards.

Edge Treatment



Edge Detail
(Will match veneer selection.)

Veneer Selection for Tops and Bases:

Bourbon Cherry (H), Henna Cherry (J), Mahogany (N), Medium Oak (M) and Natural Maple (D)*.

* Natural Maple available on veneer BASES ONLY.

	Description	Model	Ship Weight	Cube	List
Veneer Rectangle Tops E ⬠ A	144"L x 48"W (ships in two pieces)	90614G	250	12.0	\$3900
	120"L x 48"W (ships in two pieces)	90612G	207	10.1	\$3441
	96"L x 42"W	90697G	152	13.3	\$1963
	72"L x 36"W	90673G	96	7.9	\$1569
Veneer Racetrack Tops E ⬠ A	144"L x 48"W (ships in two pieces)	90714G	231	12.0	\$3900
	120"L x 48"W (ships in two pieces)	90712G	190	10.1	\$3441
	96"L x 42"W	90595G	139	13.3	\$1963
	72"L x 36"W	90571G	92	7.9	\$1569
Veneer Boat Shape Tops E ⬠ A	144"L x 48"W (ships in two pieces)	90514G	228	12.2	\$3900
	120"L x 48"W (ships in two pieces)	90512G	190	10.1	\$3441
	NOTE: Width of 144"L and 120"L tops at ends is 37½"W. 96"L x 42"W	90596G	144	13.3	\$1963
	NOTE: Width of 96"L top at ends is 34½"W. 72"L x 36"W	90572G	93	7.9	\$1569
Veneer Round Tops E ⬠ A	48" diameter	90448G	73	7.4	\$1502
	42" diameter	90442G	57	5.8	\$1279
	36" diameter	90436G	44	4.4	\$1066

Veneer Conference Tables			Veneer Bases			Laminate Bases		
Shapes Available	Top Dimensions	Seating Capacity	Number of Base Kits Required:			Number of Base Kits Required:		
			Veneer Slab Base	Cylinder Base	Veneer "X" Base	Double Column	Single Column	Metal Double Post Base
Rectangle, Racetrack, Boat	144"L x 48"W	12	1 — 91217	3 — 91222	N/A	2 — BLCOL2	N/A	N/A
Rectangle, Racetrack, Boat	120"L x 48"W	10	1 — 91213	3 — 91222	N/A	2 — BLCOL2	N/A	N/A
Rectangle, Racetrack, Boat	96"L x 42"W	8	1 — 91212	2 — 91222	2 — 91215	1 — BLCOL2	N/A	1 — BMDPO1
Rectangle, Racetrack, Boat	72"L x 36"W	6	1 — 91211	2 — 91221	2 — 91215	1 — BLCOL2	N/A	1 — BMDPO1
Round	48"D	5	N/A	1 — 91222	1 — 91215	N/A	1 — BLCOL1	N/A
Round	42"D	4	N/A	1 — 91222	1 — 91215	N/A	1 — BLCOL1	N/A
Round	36"D	4	N/A	1 — 91221	1 — 91214	N/A	1 — BLCOL1	N/A
Bases Per Kit			1	1	1	2	1	2

E ⬠ A Easy to assemble.

SPECIFY: Model.Finish

EXAMPLE: 90614G.NN

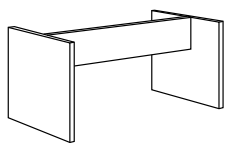

- ▶ Available in four top styles and six base styles.
- ▶ See chart on page 388 to determine base configuration requirements for selected top size.
- ▶ Bases and tops ordered separately and shipped in separate cartons.
- ▶ Tables are easy to assemble.
- ▶ All bases feature adjustable leveling glides.
- ▶ Slab bases feature longitudinal brace in matching finish.
- ▶ All tables are 29½"H and have a 1½" edge profile.
- ▶ HON Conference Tables meet or exceed ANSI/BIFMA and ISTA performance standards.

Description	Bases Included Per Kit	Model	Ship Weight	Cube	List	
Veneer Slab Base Kits 	For use with 144"L Tops	1	91217	89	6.8	\$1085
	For use with 120"L Tops	1	91213	85	6.0	\$1014
	For use with 96"L Tops	1	91212	68	4.1	\$ 796
	For use with 72"L Tops	1	91211	60	4.0	\$ 736

E A NOTE: Reference chart on page 388 for quantity required. Must use specified base size for each top size.

Veneer Cylinder Base 	For use with 48" or 42" Round, or 144"L, 120"L, or 96"L Tops (Cylinder measures 18" Diameter)	1	91222	39	12.2	\$ 853
	For use with 36" Round, or 72"L Tops (Cylinder measures 14" Diameter)	1	91221	28	8.9	\$ 831

E A NOTE: Reference chart on page 388 for quantity of bases required. Must use specified base size and quantity for each top size. Cylinder base requires 150 pounds of sand or other ballast in each base for stability (Customer to supply). Ballast permits smaller diameter base resulting in added kneespace.

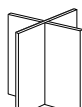
Veneer "X" Base 	For use with 48" or 42" Round, 96"L or 72"L Tops	1	91215	49	2.5	\$ 546
	For use with 36" Round Tops	1	91214	45	2.2	\$ 483

E A NOTE: Reference chart on page 388 for quantity required. Must use specified base size for each top size.

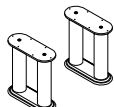
Laminate Double Column Kit 	Double Column Base Kit for 144"L, 120"L, 96"L or 72"L Top	2	BLCOL2	78	11.3	\$1059
--	---	---	---------------	----	------	--------

E A NOTE: Reference chart on page 388 for quantity of bases required. Must use specified base size and quantity for each top size. See page 390 for laminate selection. Two base kits required for 120" and 144"L tops. Each base kit consists of two supports.

One kit shown

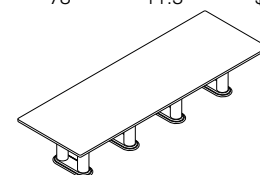

(1) 90614G and (2) BLCOL2 shown

Laminate Single Column Base 	Single Column Base for 48" Round, 42" Round or 36" Round Top	1	BLCOL1	68	10.7	\$ 474
---	--	---	---------------	----	------	--------

E A NOTE: Reference chart on page 388 for quantity of bases required. Must use specified base size and quantity for each top size. See page 390 for laminate selection.

Metal Double Post Base Kit 	Double Post Base Kit for 96"L or 72"L Top	2	BMDP01	37	4.2	\$ 532
--	---	---	---------------	----	-----	--------

E A NOTE: Reference chart on page 388 for quantity of bases required. Must use specified base size and quantity for each top size. **Black Only.** Each base kit consists of two supports.

One kit shown

E A Easy to assemble.

SPECIFY: Model.Finish

EXAMPLE: 91217.NN

Table Ordering Information

This page contains specifying information for pages 391-395.



		LAMINATES	CODES	Bases for "L" Series Tables				
				"L" Series Laminate Conference Tables	BLS01, BLS02, BLX01, BLX02	BLCY01, BLCY02, BLCY04, BLCOL2, BLCOL1	BMA01, BMX02, BMA01	BMDP01, BMT01, BTL01, BTR04
CORE	Bourbon Cherry	H	•	•	•			
	Columbian Walnut	Z	•	•	•			
	Henna Cherry	J	•	•	•			
	Mahogany	N	•	•	•			
	Shaker Cherry	F	•	•	•			
WOOD GRAIN	Medium Oak	M	•	•	•			
	Natural Maple	D	•	•	•			
SOLID	Black†	P			•			
	Charcoal	S	•	•	•			
	Light Gray	Q	•	•	•			
PATTERNED	Bronze Legacy	L3(*)	•					
	Canyon Zephyr NEW!	K9	•					
	Cloud Zephyr NEW!	K7	•					
	Desert Zephyr NEW!	K8	•					
	Morro Zephyr NEW!	L9	•					
	Shadow Zephyr NEW!	K1	•					
	Carbon Evolv	L1(*)	•					
	Cloud	G6	•		•**			
	Graphite	G3	•	•	•**			
	Gray	G2	•	•	•**			
	Grey Tigris	L6(*)	•					
	White	G1	•	•	•**			
PAINTS		CODES						
CORE	Black	P				•	•	
	Carob NEW!	T8				•		
	Charcoal	S				•		
	Greige NEW!	T5				•		
	Light Gray	Q				•		
	Muslin	T3				•		
	Putty	L				•		
	Taupe	E				•		
Tan D D	V				•			
METALLIC	Champagne Metallic NEW!	T4				•		
	Platinum Metallic NEW!	T1				•		
T-MOLD		CODES						
	Black	P	•					
	Charcoal	S	•					
	Light Gray	Q	•					

† Black (P) laminate only available on table base models BLCY01, BLCY02, BLCY01 and BLCY04
See page 13 for laminates that are still available through January 3, 2009.

NOTE: *When selecting K1-K9 and L1-L9 patterned laminates, select from the following edge colors:



"E" Thin T-Mold



"F" Bullnose T-Mold

With "E" and "F" edge treatments, select from Black (P), Charcoal (S) or Light Gray (Q).

Availability varies by series, see matrix at left.



"G" 1 1/2" 2MM
(10500 Design)



"H" 1 3/4" 2MM

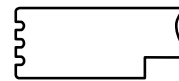

"K" Ribbon
(Valido Design)

With "G", "H" and "K" edge treatments, select from Bourbon Cherry (H), Charcoal (S), Columbian Walnut (Z), Henna Cherry (J), Light Gray (Q), Mahogany (N), Medium Oak (M), Natural Maple (D), Shaker Cherry (F).

NOTE: ** Patterned Laminates Cloud (G6), Graphite (G3), Gray (G2) and White (G1) will no longer be available on Models BLCY01, BLCY02, BLCY01, BLCY02, BLCY04, BLCOL2 and BLCOL1 1/3/2009.

© Core Product Line
D D Discontinued 12/26/2009.

- ▶ Bases and tops ordered separately and shipped in separate cartons, ETA.
- ▶ 120"L and 144"L tops ship in two pieces to facilitate handling and installation.
- ▶ 96"L, 72"L and 60"L tops are one piece.
- ▶ Tops are premium high pressure laminate over solid core high-performance particleboard.
- ▶ Tops can be ordered in one of five edge options (see below).
- ▶ Rectangle and Boat shaped tops have radius corners.
- ▶ Tops with bases are 29½"H.
- ▶ Two piece tops are secured and supported by steel stretchers, a laminate center rail, worksurface connectors and flat brackets to facilitate alignment and minimize deflection.
- ▶ Underside of tops features a factory-installed template. The template, which is tri-lingual, facilitates assembly of the base to the top by designating the specific attachment location for multiple base designs. Bases attach to top with self-tapping screws; no drilling is required.
- ▶ Edge treatments "E" and "F" are ONLY available in Q, P or S colors.
- ▶ Edge treatments "G", "H" and "K" color will match laminate top selection EXCEPT when patterned laminates are specified.
- ▶ Bases shown on pages 392 and 393.
- ▶ See chart below to determine base compatibility for selected top size.
- ▶ Meets or exceeds ANSI/BIFMA and ISTA performance standards.

Edge Treatments

- ▶ **HOW TO ORDER**
- 1) Select desired model numbers.
 - 2) Select desired top edge treatment.
 - 3) Replace the (?) after each model number with the suffix representing the chosen top edge treatment.

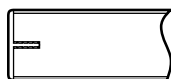

"E" T-Mold

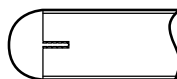

"F" Bullnose T-Mold

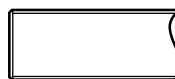

"G" 10500 Series
1½" Edge



"H" 1½" Smooth,
Flat Edge

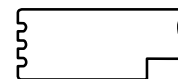

"K" 1½" Valido
Ribbon Edge

(Color must be selected, edge treatments "E" and "F" are ONLY available in Q, P or S colors.)

(Will match laminate selection EXCEPT when specifying patterned laminate colors.)

Description	Seating Capacity	Model	Ship Wt.			Cube			List by Edge Treatment				
			"E", "F", "G"	"H", "K"	"K"	"E", "F", "G"	"H", "K"	"K"	"E"	"F"	"G"	"H"	"K"
Rectangular Shaped Laminate Tops 	144"L x 48"W	12	LC48144(?)	270	310	11.5	13.3	\$ 786	\$ 841	\$ 858	\$1012	\$1126	
	120"L x 48"W	10	LC48120(?)	230	265	9.7	11.2	\$ 698	\$ 758	\$ 766	\$ 911	\$1032	
	96"L x 48"W	8	LC4896(?)	200	210	14.1		\$ 592	\$ 608	\$ 616	\$ 740	\$ 818	
	72"L x 36"W	6	LC3672(?)	115	120	8.2		\$ 392	\$ 426	\$ 435	\$ 554	\$ 627	
	60"L x 30"W	4	LC3060(?)	76	N/A	5.9		\$ 309	\$ 335	\$ 343	N/A	N/A	
NOTE: On 144" and 120" models, woodgrain colors will not have exact grain alignment in the center, where the two halves meet.													
144" and 120" ship in two pieces													
Racetrack Shaped Laminate Tops 	144"L x 48"W	12	LA48144(?)	255	295	11.5	13.3	\$ 814	\$ 857	\$ 876	\$1027	\$1152	
	120"L x 48"W	10	LA48120(?)	215	250	9.7	11.2	\$ 704	\$ 771	\$ 785	\$ 948	\$1045	
	96"L x 48"W	8	LA4896(?)	190	215	14.1		\$ 599	\$ 616	\$ 623	\$ 747	\$ 837	
	72"L x 36"W	6	LA3672(?)	110	130	8.2		\$ 421	\$ 446	\$ 461	\$ 589	\$ 663	
NOTE: On 144" and 120" models, woodgrain colors will not have exact grain alignment in the center, where the two halves meet.													
144" and 120" ship in two pieces													
Boat Shaped Laminate Tops 	144"L x 48"W	12	LB48144(?)	260	300	11.5	13.3	\$ 798	\$ 841	\$ 865	\$1014	\$1138	
	120"L x 48"W	10	LB48120(?)	220	255	9.7	11.2	\$ 692	\$ 755	\$ 772	\$ 933	\$1031	
	96"L x 48"W	8	LB4896(?)	180	200	14.1		\$ 592	\$ 607	\$ 612	\$ 740	\$ 833	
	72"L x 36"W	6	LB3672(?)	100	120	8.2		\$ 410	\$ 428	\$ 440	\$ 569	\$ 645	
NOTE: Width of 144"L, 120"L and 96"L tops at ends is 38"W.													
NOTE: Width of 72"L top at ends is 30"W.													
On 144" and 120" models, woodgrain colors will not have exact grain alignment in the center, where the two halves meet.													
144" and 120" ship in two pieces													
Round Laminate Tops 	48" diameter	4	LD48(?)	75	85	7.3		\$ 335	\$ 363	\$ 367	\$ 486	\$ 530	
	42" diameter	4	LD42(?)	60	70	5.7		\$ 298	\$ 325	\$ 332	\$ 454	\$ 496	
	36" diameter	3	LD36(?)	47	60	4.3		\$ 260	\$ 300	\$ 308	\$ 391	\$ 423	

Shapes Available	Top Dimensions	Number of Base Kits Required for Tops Without Cord/Power Cutout(s)											
		Laminate Slab Base	Reversible Laminate Curved Base w/ Plinth	Laminate Cylinder Base	Laminate Cylinder Base w/Wire Management	Laminate "X" Base	Double Column Base	Single Column Base	Metal "X" Base	Reversible Metal Arc Base	Metal Double Post Base	Metal Cannon Tubular Leg Base	Half Arch Leg Base
Rectangle, Racetrack, Boat	144" x 48"W	(1) BLS02	(1) BLCPO1	(2) BLCY02	(2) BLCY04	(2) BLX02	(1) BLCOL2	N/A	(2) BMX02	N/A	N/A	N/A	(3) BTL01
Rectangle, Racetrack, Boat	120" x 48"W	(1) BLS02	(1) BLCPO1	(2) BLCY02	(2) BLCY04	(2) BLX02	(1) BLCOL2	N/A	(2) BMX02	N/A	N/A	N/A	(3) BTL01
Rectangle, Racetrack, Boat	96" x 48"W	(1) BLS02	(1) BLCPO1	(2) BLCY02	(2) BLCY04	(2) BLX02	(1) BLCOL2	N/A	(2) BMX02	(1) BMA01	(1) BMDP01	(1) BMT01	(2) BTL01
Rectangle, Racetrack, Boat	72" x 36"W	(1) BLS01	(1) BLCPO1	(2) BLCY01	N/A	(2) BLX01	(1) BLCOL2	N/A	(2) BMX01	(1) BMA01	(1) BMDP01	(1) BMT01	(2) BTL01
Rectangle	60" x 30"W	(1) BLS01	(1) BLCPO1	N/A	N/A	N/A	N/A	N/A	N/A	N/A	(1) BMDP01	(1) BMT01	N/A
Round	48"	N/A	N/A	(1) BLCY02	(1) BLCY04	(1) BLX02	N/A	(1) BLCOL1	(1) BMX02	(1) BMA01	N/A	(1) BMT01	(1) BTR04
Round	42"	N/A	N/A	(1) BLCY02	(1) BLCY04	(1) BLX02	N/A	(1) BLCOL1	(1) BMX02	(1) BMA01	N/A	(1) BMT01	(1) BTR04
Round	36"	N/A	N/A	(1) BLCY01	N/A	(1) BLX01	N/A	(1) BLCOL1	(1) BMX01	N/A	N/A	N/A	N/A
Bases Per Kit		2	2	1	1	1	2	1	1	2	2	4	1

NOTE: Laminate cylinder base with wire management (BLCY04) can be used under tops without cord/power cutouts, however, the wire management routing feature through the base cannot be accessed.



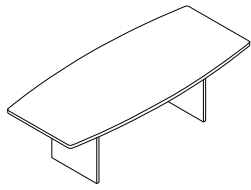

Easy to assemble.

**SPECIFY: Model(Edge).Laminate/T-mold
Model(Edge).Laminate**

**EXAMPLES: LC48144E.NQ
LC48144H.N**

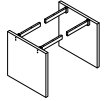
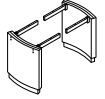

- ▶ Bases and tops ordered separately and shipped in separate cartons, ETA.
- ▶ Tops with bases are 29½"H.
- ▶ Bases feature adjustable leveling glides.
- ▶ Laminate slab, curved with plinth, cylinder and "X" base require specifying a laminate color.
- ▶ Laminate slab and curved bases feature four steel stretcher ends, which assemble to the steel stretcher support included with the top.
- ▶ Existing Cylinder Base models BLCY01, BLCY02 and Curved Base with Plinth model BLCP01 now also available in **Black (P)**.
- ▶ Cylinder table base with wire management (BLCY04) allows for cords to route through base.
- ▶ The curved with plinth and arc bases can be reversed (convex or concave).
- ▶ See chart on page 391 to determine base configuration requirements for selected top size.
- ▶ See page 390 for available laminate/paint color options.
- ▶ Meets or exceed ANSI/BIFMA and ISTA performance standards.

	Description	Bases Included Per Kit	Model	Ship Weight	Cube	List
	Laminate Slab Base					
	Slab Base for 144"L, 120"L or 96"L Laminate Top	2	BLS02	86	4.7	\$ 411
	Slab Base for 72"L or 60"L Laminate Top	2	BLS01	73	4.0	\$ 387
	E A NOTES: Reference chart on page 391 for quantity of bases required. Must use specified base size and quantity for each top size.					
	Reversible Laminate Curved Base with Plinth					
	Curved Base with Plinth for 144"L, 120"L, 96"L, 72"L or 60"L Laminate Top	2	BLCP01	57	5.6	\$ 545
	E A NOTES: Reference chart on page 391 for quantity of bases required. Must use specified base size and quantity for each top size. Curved base can be reversed. (convex or concave) Now also available in Black (P).					
	Laminate Cylinder Base					
	18" Diameter Cylinder Base for 48" Round, 42" Round, 144"L, 120"L or 96"L Laminate Top	1	BLCY02	37	11.6	\$ 442
	14" Diameter Cylinder Base for 36" Round or 72"L Laminate Top	1	BLCY01	30	8.3	\$ 399
	E A NOTES: Reference chart on page 391 for quantity of bases required. Must use specified base size and quantity for each top size. Cylinder base requires 150 pounds of sand or other ballast in each base for stability (Customer to supply). Ballast permits smaller diameter base resulting in added kneespace. Now also available in Black (P).					
	Laminate Cylinder Base w/Wire Management					
	18" Diameter Cylinder Base w/Wire Management for 42" Round, 48" Round, 120"L or 144"L Laminate Tops		BLCY04	45	11.6	\$ 559
	E A NOTES: Reference chart on page 391 for quantity of base required. Cylinder base requires 150 pounds of sand or other ballast in each base for stability (Customer to supply). Ballast permits smaller diameter base resulting in added kneespace. Color availability includes Black (P).					
	Laminate "X" Base					
	Laminate "X" Base for 48" Round, 42" Round, 144"L, 120"L or 96"L Laminate Top	1	BLX02	75	3.6	\$ 306
	Laminate "X" Base for 36" Round or 72"L Laminate Top	1	BLX01	62	3.1	\$ 284
	E A NOTES: Reference chart on page 391 for quantity of bases required. Must use specified base size and quantity for each top size.					

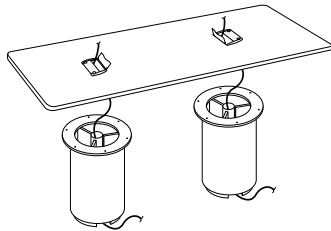

E A Easy to assemble.

SPECIFY: Model.Color

EXAMPLE: BLS02.N

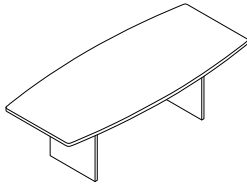





- ▶ Bases and tops ordered separately and shipped in separate cartons, ETA.
- ▶ Bases feature adjustable leveling glides.

- ▶ Tops with bases are 29½"H.
- ▶ The curved with plinth and arc bases can be reversed (convex or concave).

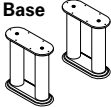
- ▶ Metal "X," arc, half-arch and cannon tubular bases require specifying a paint color.
- ▶ When specifying Metal "X" or Metal Arc bases with Metallic paint, add a "2" at the end of the model number. See specifying example below.

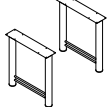
- ▶ See chart on page 391 to determine base configuration requirements for selected top size.
- ▶ See page 390 for available laminate/paint color options.
- ▶ Meets or exceed ANSI/BIFMA and ISTA performance standards.

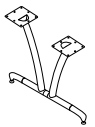
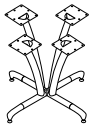
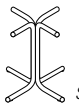
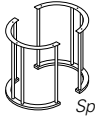
Description		Bases Included Per Kit	Model	Ship Weight	Cube	List	
 <p>Laminate Double Column Base</p>	Double Column Base for 144"L, 120"L, 96"L or 72"L Laminate Top	2	BLCOL2	78	11.3	\$1059	
	<p>E A NOTES: Reference chart on page 391 for quantity of bases required. Must use specified base size and quantity for each top size.</p>						
 <p>Laminate Single Column Base</p>	Single Column Base for 48" Round, 42" Round or 36" Round Top	1	BLCOL1	68	10.7	\$ 474	
	<p>E A NOTES: Reference chart on page 391 for quantity of bases required. Must use specified base size and quantity for each top size. Works well with models LD36E, LD36F, LD36G. Will not work with models LD36H or LD36K.</p>						
 <p>Metal Double Post Base</p>	Double Post Base for 96"L, 72"L or 60"L Laminate Top	2	BMDP01	37	4.2	\$ 532	
	<p>E A NOTES: Reference chart on page 391 for quantity of bases required. Must use specified base size and quantity for each top size. Black Only</p>						
 <p>Metal Cannon Tubular Leg Base</p>	Cannon Tubular Leg Base for 48" Round, 42" Round, 96"L, 72"L or 60"L Laminate Top	4	BMT01	46.2	5.1	\$ 499	
	<p><i>Specify paint</i> E A NOTES: Reference chart on page 391 for quantity of bases required. Must use specified base size and quantity for each top size. Black (P) only.</p>						
	Half-arch Leg Base (1 per carton) Single color (leg and feet color match).		BTL01	21	2.1	\$ 359	
	<p>NOTES: Black (P) ONLY. Reference charts on pages 391 and 394 for quantity of bases required. Must use specified base size and quantity for each top size. E A Cannot be used on 60"L x 30"W Rectangle table tops.</p>						
	Half-arch Leg Base (1 per carton) Single color (leg and feet color match).		BTR04	44	24.0	\$ 582	
	<p>NOTES: Black (P) ONLY. Reference charts on pages 391 and 394 for quantity of bases required. Must use specified base size and quantity for each top size. E A</p>						
Description		Bases Included Per Kit	Model	Ship Weight	Cube	List by Paint Grade	
 <p>Metal "X" Base</p>	Metal "X" Base for 48" Round, 42" Round, 144"L, 120"L or 96"L Laminate Top	1	BMX02	33	4.1	\$ 234	\$ 275
	Metal "X" Base for 36" Round or 72"L Laminate Top	1	BMX01	31	4.1	\$ 245	\$ 264
<p><i>Specify paint</i> E A NOTES: Reference chart on page 391 for quantity of bases required. Must use specified base size and quantity for each top size.</p>							
 <p>Reversible Metal Arc Base</p>	Metal Arc Base for 48" Round, 42" Round, 96"L or 72"L Laminate Top	2	BMA01	45	12.0	\$ 579	\$ 609
	<p>E A NOTES: Reference chart on page 391 for quantity of bases required. Must use specified base size and quantity for each top size. Arc Base can be reversed. (convex or concave)</p>						

E A Easy to assemble.

**SPECIFY: Model.Color
Model/Paint Grade "2": Paint**

**EXAMPLES: BLCOL2.S
BMX022.T1**

"L" Series Laminate Conference Tables with Wire Management

GSA SIN 711-11
Type 5

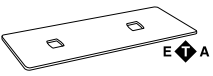

- ▶ 72"L, 96"L, 42" and 48" round tops are available with cord/power cutout. 120"L and 144"L tops are available with two cutouts.
- ▶ Cutout sized for grommet or data/power module (ordered separately — see page 395).
- ▶ Tops with cord/power cutout(s) include wire management tray kit.
- ▶ Bases and tops ordered separately and shipped in separate cartons, ETA.
- ▶ 120"L and 144"L tops ship in two pieces to facilitate handling and installation; these top sizes in woodgrain colors will not have exact grain alignment in the center where the two halves meet.
- ▶ Tops are premium high pressure laminate over solid core high-performance particleboard.
- ▶ Tops can be ordered in one of five edge options (see page 391).
- ▶ Rectangle and Boat-shaped tops have radius corners.
- ▶ Tops with bases are 29½"H.
- ▶ Edge treatments "E" and "F" are ONLY available in Q, P or S colors.
- ▶ Edge treatments "G", "H" and "K" color will match laminate top selection EXCEPT when patterned laminates are specified.
- ▶ Bases shown on pages 392-393.
- ▶ See chart below to determine base compatibility for selected top size.
- ▶ Meets or exceeds ANSI/BIFMA and ISTA performance standards.

Description	Seating Capacity	Model	Ship Wt.	Ship Wt.	Cube	List by Edge Treatment					
			"E", "F", "G"	"H", "K"		"E"	"F"	"G"	"H"	"K"	
Rectangular Shaped Laminate Tops 	144"L x 48"W	12	LC48144(?)T	238	308	11.4	\$ 926	\$ 981	\$ 998	\$1152	\$1266
	120"L x 48"W	10	LC48120(?)T	233	258	9.6	\$ 838	\$ 898	\$ 906	\$1051	\$1172
	96"L x 48"W	8	LC4896(?)S	199	209	14.1	\$ 662	\$ 678	\$ 686	\$ 810	\$ 888
	72"L x 36"W	6	LC3672(?)S	114	119	8.2	\$ 462	\$ 496	\$ 505	\$ 624	\$ 697
	60"L x 30"W	4	LC3060(?)S	75	N/A	5.9	\$ 379	\$ 405	\$ 413	N/A	N/A

NOTES: Grommets or data/power module kits must be purchased separately. See page 395. Bases shown on pages 392 and 393. 144" and 120" tops have two cord/power cutouts; 96", 72" and 60" models have one cord/power cutout positioned in the center of the top.

144" and 120"L ship in two pieces

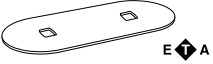
Racetrack Shaped Laminate Tops 	144"L x 48"W	12	LA48144(?)T	298	303	11.4	\$ 954	\$ 997	\$1016	\$1167	\$1292
	120"L x 48"W	10	LA48120(?)T	228	253	9.6	\$ 844	\$ 911	\$ 925	\$1088	\$1185
	96"L x 48"W	8	LA4896(?)S	189	214	14.1	\$ 669	\$ 686	\$ 693	\$ 817	\$ 907
	72"L x 36"W	6	LA3672(?)S	109	129	8.2	\$ 491	\$ 516	\$ 531	\$ 659	\$ 733
	NOTES: Grommets or data/power module kits must be purchased separately. See page 395. Bases shown on pages 392 and 393. 144" and 120" tops have two cord/power cutouts; 96" and 72" models have one cord/power cutout positioned in the center of the top.										

144" and 120"L ship in two pieces

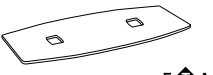
Boat Shaped Laminate Tops 	144"L x 48"W	12	LB48144(?)T	243	293	11.4	\$ 938	\$ 981	\$1005	\$1154	\$1278	
	120"L x 48"W	10	LB48120(?)T	218	243	9.6	\$ 832	\$ 895	\$ 912	\$1073	\$1171	
	96"L x 48"W	8	LB4896(?)S	179	199	14.1	\$ 662	\$ 677	\$ 682	\$ 810	\$ 903	
	NOTES: Grommets or data/power module kits must be purchased separately. See page 395. Width of 144"L, 120"L and 96"L tops at ends is 38"W. Bases shown on pages 392 and 393. 144" and 120" tops have two cord/power cutouts; 96" and 72" models have one cord/power cutout positioned in the center of the top.											
	72"L x 36"W	6	LB3672(?)S	99	119	8.2	\$ 480	\$ 498	\$ 510	\$ 639	\$ 715	

NOTES: Grommets or data/power module kits must be purchased separately. See page 405. Width of 72"L top at ends is 30"W.

144" and 120"L ship in two pieces

Round Laminate Tops 	48" diameter	4	LD48(?)S	74	84	7.3	\$ 405	\$ 433	\$ 437	\$ 556	\$ 600
	42" diameter	4	LD42(?)S	59	69	5.7	\$ 368	\$ 395	\$ 402	\$ 524	\$ 566
	NOTE: Grommets or data/power module kit must be purchased separately. See page 395.										
NOTES: Bases BMX02, BMX01, BMA01 and BTR04 will not accommodate the vertical wire management tray component of the wire management tray kit (model WMT1). Bases BLCOL1, BLCY01 and BLCY02 will not accommodate any grommet positions when used as a single base.											







Laminate Conference Tables		Number of Base Kits Required for Tops With Cord/Power Cutout(s)											
Shapes Available	Top Dimensions	Laminate Slab Base	Reversible Laminate Curved Base w/ Plinth	Laminate Cylinder Base	Laminate Cylinder Base w/Wire Management	Laminate "X" Base	Laminate Double Column Base	Laminate Single Column Base	Metal "X" Base	Reversible Metal Arc Base	Metal Double Post Base	Metal Cannon Tubular Leg Base	Half Arch Leg Base
Rectangle, Racetrack, Boat	144"L x 48"W	(1) BLS02	(1) BLCPO1	N/A	(2) BLCY04	(2) BLX02	(1) BLCOL2	N/A	(2) BMX02	N/A	N/A	N/A	(3) BTL01
Rectangle, Racetrack, Boat	120"L x 48"W	(1) BLS02	(1) BLCPO1	N/A	(2) BLCY04	(2) BLX02	(1) BLCOL2	N/A	(2) BMX02	N/A	N/A	N/A	(3) BTL01
Rectangle, Racetrack, Boat	96"L x 48"W	(1) BLS02	(1) BLCPO1	(2) BLCY02	(2) BLCY04*	(2) BLX02	(1) BLCOL2	N/A	(2) BMX02	(1) BMA01	(1) BMDPO1	(1) BMT01	(2) BTL01
Rectangle, Racetrack, Boat	72"L x 36"W	(1) BLS01	(1) BLCPO1	(2) BLCY01	N/A	(2) BLX01	(1) BLCOL2	N/A	(2) BMX01	(1) BMA01	(1) BMDPO1	(1) BMT01	(2) BTL01
Rectangle	60"L x 30"W	(1) BLS01	(1) BLCPO1	N/A	N/A	N/A	N/A	N/A	N/A	N/A	(1) BMDPO1	(1) BMT01	N/A
Round	48"	N/A	N/A	N/A	(1) BLCY04	(1) BLX02	N/A	N/A	(1) BMX02	(1) BMA01	N/A	(1) BMT01	(1) BTR04
Round	42"	N/A	N/A	N/A	(1) BLCY04	(1) BLX02	N/A	N/A	(1) BMX02	(1) BMA01	N/A	(1) BMT01	(1) BTR04
Bases Per Kit		2	2	1		1	2	1	1	2	2	4	1

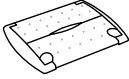

*NOTE: BLCY04 interior cord routing not accessible on 96"L top.

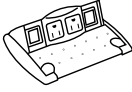
 Easy to assemble.

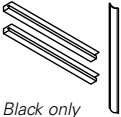
SPECIFY: Model(Edge).Laminate/T-mold
Model(Edge).Laminate

EXAMPLES: LC48144ET.NQ
LC48144H.N

	Description	Model	Ship Weight	Cube	List
 <p>Wire Management Grommet</p>	<p>Grommet includes:</p> <ul style="list-style-type: none"> • One 7" x 5" grommet. • May be in closed position while in use. • Dimensions: 7"L x 5"W. Fits 1" - 1 1/8" thick worksurfaces. • Grommet design matches Interport Data/Power Module cover. • Intended for use with table tops shown on page 394 ONLY. • Available in Black (P) only. 	WMK1	1 	1.0	\$ 65
 <p>Interport Data/Power Module Kit</p>	<p>Kit includes:</p> <ul style="list-style-type: none"> • (1) Interport Data/Power Module. • Fits all grommet position access holes. • Can be used stand alone or in modular multiples; may be used in closed position while in use; reversible without removing base from worksurface. • (2) simplexes; 6ft. 15 AMP cord; (2) voice/data ports; UL Listed; jacks and couplers sold separately. • Dimensions: 7"L x 5"W. Fits 1" - 1 1/8" thick worksurfaces. • Intended for use with table tops shown on page 394 ONLY. • Available in Black (P) only. 	WMP1	1 	1.0	\$ 260
 <p>Wire Management Trough Kit</p> <p><i>Black only</i></p>	<p>Kit includes:</p> <ul style="list-style-type: none"> • (1) 24"L Vertical Wire Management Tray. • (2) 24"L Horizontal Wire Management Trays. • Intended for use with table tops shown on page 394 ONLY. • Available in Black finish only. 	WMT1	1 	1.0	\$ 83

 **Easy to assemble.**
 **Shippable by small-package carrier.**

SPECIFY: Model.color

EXAMPLE: WMK1.P

- ▶ **NEW!** Platinum Metallic painted legs.
- ▶ Perpetual tables are designed for today's busy and versatile work environment. Perpetual provides limitless flexibility and functionality and incorporates a lightness of scale and an open architectural style that fits well with today's varied work places.
- ▶ Tables can be ordered in one of two styles of edge treatment. The distinctive legs are formed from die-cast aluminum and painted in Platinum Metallic color.
- ▶ Meets or exceeds ANSI/BIFMA and ISTA performance standards.

Table Finish Options

"A" Thermoform (Top and edge are one matching piece)

Woodgrain: Bourbon Cherry (H), Natural Maple (D), Henna Cherry (J), Mahogany (N).

"B" 2MM Edge Treatment: (Edgeband color is pre-determined based on laminate selection)

Woodgrain Laminate: Bourbon Cherry (H), Natural Maple (D), Henna Cherry (J), Mahogany (N).

Woodgrain laminate will have matching 2MM edgeband.

Patterned Laminate: White (G1), Gray (G2), Graphite (G3).

Patterned laminate will have the following pre-determined 2MM edgeband: Light Gray (Q) on White (G1) and Gray (G2), Charcoal (S) on Graphite (G3).

Leg Finish Option

Perpetual table legs are only available in Platinum Metallic (T1) paint.

Pedestal Seat Options

Pedestal seat fabric options may be selected from seating fabrics — see pages 274-279.

NOTE: Not available in BK, EC, EE, EG, EJ, SR, SS and WP fabrics.

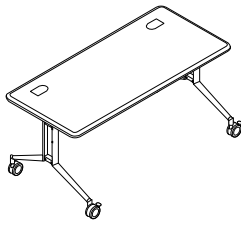

- ▶ **NEW!** Platinum Metallic painted legs.
- ▶ Tables ship as a complete unit with base and top in one carton. ETA.
- ▶ Legs are standard in Platinum Metallic (T1).
- ▶ Tops can be ordered in one of two edge styles.
- ▶ Tables are 29½"H.
- ▶ Laminate tops are high-pressure laminate over 1½" thick solid core high-performance particleboard.
- ▶ Thermoform tops are 1½" thick MDF vacuum formed with a membrane press application of rigid vinyl edgeband.
- ▶ Use with Perpetual Seating on pages 302-309.
- ▶ All desks and tables are mobile except for conference, round and square which come standard with glides.
- ▶ Mobile tables include two locking and two non-locking casters.
- ▶ Two wire management grommets standard in all 66"W x 36"D through 48"W x 24"D rectangle and concave tables. Grommets standard in Platinum Metallic (T1).
- ▶ Meets or exceeds ANSI/BIFMA and ISTA performance standards.

Edge Treatments

- ▶ **HOW TO ORDER**
- 1) Select desired model numbers.
 - 2) Select desired top edge treatment.
 - 3) Replace the (?) after each model number with the suffix representing the chosen top edge treatment.



"A" Thermoform
(Color must be selected.)

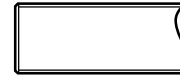

"B" 2MM Matching
(Color is pre-determined, NOT selected.)

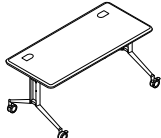
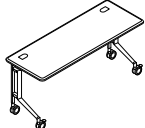
	Description	Model	Ship Weight	Cube	List Price by Edge Treatment	
					"A"	"B"
Rectangular Tables  Model PR3066A shown  Model PR2466A shown	72"W x 36"D x 29½"H (No grommets)	PR3672(?)	134	7.3	\$1734	\$1504
	66"W x 36"D x 29½"H	PR3666(?)	128	6.7	\$1588	\$1400
	72"W x 30"D x 29½"H	PR3072(?)	120	5.7	\$1670	\$1440
	66"W x 30"D x 29½"H	PR3066(?)	113	5.7	\$1523	\$1336
	60"W x 30"D x 29½"H	PR3060(?)	107	5.2	\$1410	\$1265
	48"W x 30"D x 29½"H	PR3048(?)	86	4.3	\$1282	\$1179
	72"W x 24"D x 29½"H (Half-leg base)	PR2472(?)	96	4.6	\$1588	\$1361
	66"W x 24"D x 29½"H (Half-leg base)	PR2466(?)	92	4.3	\$1443	\$1259
	60"W x 24"D x 29½"H (Half-leg base)	PR2460(?)	87	4.3	\$1331	\$1187
	48"W x 24"D x 29½"H (Half-leg base)	PR2448(?)	71	3.2	\$1200	\$1099
60"W x 18"D x 29½"H (Half-leg base, no grommets)	PR1860(?)	77	3.0	\$1265	\$1122	
48"W x 18"D x 29½"H (Half-leg base, no grommets)	PR1848(?)	61	2.5	\$1135	\$1036	

NOTE: Models PR1860(?) and PR1848(?) are standard with two glides and two non-locking casters.

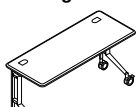
Nesting Tables 	60"W x 24"D x 29½"H	PRN2460(?)	92	11.7	\$1829	\$1676
	48"W x 24"D x 29½"H	PRN2448(?)	76	9.6	\$1697	\$1588
	60"W x 18"D x 29½"H (No grommets)	PRN1860(?)	82	11.7	\$1763	\$1612
	48"W x 18"D x 29½"H (No grommets)	PRN1848(?)	66	9.6	\$1635	\$1524

NOTES: Models PRN1860(?) and PRN1848(?) are standard with two glides and two non-locking casters.
For Modesty Panels, see page 401. Table may be nested with modesty panel attached.
Nesting space requirements: 19"D for first table and 9"D for each additional table.
Last nested table can be stored in the same footprint when reversed.
Nesting tables cannot be used with electrical.

 Easy to assemble.

SPECIFY: Model(Edge).Laminate
Model(Edge).Laminate/Leg Finish (Platinum Metallic (T1))

EXAMPLES: PR3672A.H
PR3672(?).HT1

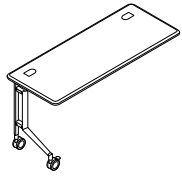

- ▶ **NEW!** Platinum Metallic painted legs.
- ▶ Legs are standard in Platinum Metallic (T1).
- ▶ Tops can be ordered in one of two edge styles.
- ▶ Desks and tables are 29½"H.
- ▶ Thermoform tops are 1½" thick MDF vacuum formed with a membrane press application of rigid PVC vinyl.
- ▶ Laminate tops are high-pressure laminate over 1½" thick solid core high-performance particleboard.
- ▶ Use with Perpetual Seating on pages 302-309.
- ▶ All tables are mobile except for conference, round and square which come standard with glides.
- ▶ Mobile tables include two locking and two non-locking casters.
- ▶ Two wire management grommets standard in all 66"W x 36"D through 48"W x 24"D rectangle and concave tables. Grommets standard in Platinum Metallic (T1).
- ▶ Meets or exceeds ANSI/BIFMA and ISTA performance standards.

	Description	Model	Ship Weight	Cube	List Price by Edge Treatment "A" "B"	
Returns Model PRR2460A shown	60"W x 24"D x 29½"H - Right (Half-leg base, two grommets)	PRR2460(?)	80	4.3	\$1151	\$1029
	48"W x 24"D x 29½"H - Right (Half-leg base, two grommets)	PRR2448(?)	64	3.2	\$1039	\$ 950
	42"W x 24"D x 29½"H - Right (Half-leg base, one grommet)	PRR2442(?)	58	2.2	\$ 982	\$ 914
	36"W x 24"D x 29½"H - Right (Half-leg base, one grommet)	PRR2436(?)	52	1.8	\$ 928	\$ 876
 Model PRL2460A shown	60"W x 24"D x 29½"H - Left (Half-leg base, two grommets)	PRL2460(?)	80	4.3	\$1151	\$1029
	48"W x 24"D x 29½"H - Left (Half-leg base, two grommets)	PRL2448(?)	64	3.2	\$1039	\$ 950
	42"W x 24"D x 29½"H - Left (Half-leg base, one grommet)	PRL2442(?)	58	2.2	\$ 982	\$ 914
	36"W x 24"D x 29½"H - Left (Half-leg base, one grommet)	PRL2436(?)	52	1.8	\$ 928	\$ 876
Conference Tables E A	96"W x 48"D x 29½"H	PC4896(?)	206	12.7	\$2361	\$2127
	72"W x 36"D x 29½"H	PC3672(?)	134	7.3	\$2205	\$1971
Concave Tables E A	66"W x 36"D x 29½"H	PB3666(?)	126	6.7	\$1609	\$1423
	66"W x 30"D x 29½"H	PB3066(?)	111	5.7	\$1537	\$1356
	60"W x 30"D x 29½"H	PB3060(?)	104	5.2	\$1427	\$1286
	48"W x 30"D x 29½"H	PB3048(?)	84	4.3	\$1301	\$1201
	60"W x 24"D x 29½"H (Half-leg base)	PB2460(?)	86	4.3	\$1357	\$1214
48"W x 24"D x 29½"H (Half-leg base)	PB2448(?)	68	3.3	\$1214	\$1114	
Oval Tables E A	60"W x 36"D x 29½"H	PV3660(?)	120	6.2	\$1458	\$1313
Half-Round Tables E A	60"W x 34"D x 29½"H	PA30(?)	90	5.9	\$1310	\$1168
	48"W x 28"D x 29½"H (Half-leg base)	PA24(?)	78	4.0	\$1167	\$1069
Round Tables Model PN48A shown	48" Diameter x 29½"H	PN48(?)	89	6.9	\$1538	\$1392
	36" Diameter x 29½"H	PN36(?)	66	4.2	\$1294	\$1193
Square Tables Model PS36A shown	48"W x 48"D x 29½"H	PS48(?)	125	6.9	\$1538	\$1392
	36"W x 36"D x 29½"H	PS36(?)	80	4.2	\$1294	\$1193

E A Easy to assemble.

SPECIFY: Model(Edge).Laminate
Model(Edge).Laminate.Leg Finish (Platinum Metallic (T1))

EXAMPLES: PRR2460A.H
PRR2460A.HT1

index accessories education tables storage & files seating systems desking

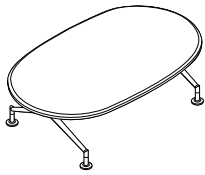

- ▶ **NEW!** Platinum Metallic painted legs.
- ▶ Perpetual Occasional tables recommended for use with Perpetual Modular seating. See pages 308-309.
- ▶ Corner Units include support leg and attachment brackets. Must be attached to rectangular tables.
- ▶ Legs are standard in Platinum Metallic (T1).
- ▶ Meets or exceeds ANSI/BIFMA and ISTA performance standards.

	Description	Model	Ship Weight	Cube	List Price by Edge Treatment "A" "B"	
Occasional Tables	Oval Coffee Table, 60"W x 36"D x 17"H	PVRF3660A	115	6.2	\$1656	N/A
						
SIN 711-11						
	Rectangle Coffee Table, 60"W x 30"D x 17"H	PRRF3060A	102	5.2	\$1607	N/A
						
SIN 711-11						
	Square End Table, 26"W x 26"D x 23½"H	PSRF26A	62	2.3	\$1294	N/A
						
SIN 711-11						



GSA — Above model receives Computer Furniture discounting.

GSA — Above model receives Computer Furniture discounting.

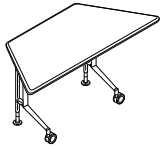
GSA — Above model receives Computer Furniture discounting.

Trapezoid Tables	60"W x 30"D x 29½"H (Half-leg base)	PT3060(?)	81	5.2	\$1443	\$1298
	48"W x 24"D x 29½"H (Half-leg base)	PT2448(?)	74 <td>3.2 <td>\$1361 <td>\$1218</td> </td></td>	3.2 <td>\$1361 <td>\$1218</td> </td>	\$1361 <td>\$1218</td>	\$1218
						



Bridges	48"W x 24"D x 29½"H (2 Grommets)	PRB2448(?)	40	4.3	\$ 608	\$ 514
	42"W x 24"D x 29½"H (1 Grommet)	PRB2442(?)	35	3.8	\$ 566	\$ 484
						
PRB2448A						
						
PRB2442A						

NOTE: For use with rectangular tables.

Corner Units	42"W x 30"D Left, 30"D Right x 29½"H	PRC42BB(?)	76	6.8	\$ 923	\$ 848
	36"W x 24"D Left, 24"D Right x 29½"H	PRC36AA(?)	53	3.5	\$ 778	\$ 718
						
						

NOTE: Must be attached to rectangular tables.

Approach Side

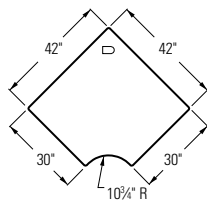

PRC42BB(?)

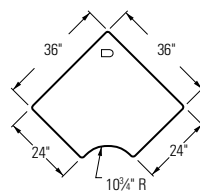



PRC36AA(?)

 **Easy to assemble.**

**SPECIFY: Model(Edge).Laminate
Model(Edge).Laminate/Leg Finish (Platinum Metallic (T1))**

**EXAMPLES: PVRF3660A.H
PVRF3660A.HT1**

- ▶ **NEW!** Platinum Metallic painted legs.
- ▶ Spacer and glides convert mobile tables to freestanding and provide 1" of adjustability.
- ▶ Ganging brackets allow rectangle and concave tables to be ganged side-to-side or back-to-back. One model PGANG required per table.
- ▶ Wire management trays cannot be used with nesting tables.
- ▶ Wire management trays are designed to complement the tables and offer multiple points to access wires.
- ▶ Vertical wire management neatly routes wires from the worksurface to the floor.
- ▶ CPU holder is adjustable in height and accommodates most CPU's. Holder mounts on the inside or outside of table leg.
- ▶ File Holder mounts on the outside of desk/table leg and holds letter and legal files as well as binders. For use with 48" and 60" Rectangular and Concave Tables.
- ▶ Compatible with 850500, 850000, HKB900, HKB700, HKB200 keyboards, shown on pages 466-468.
- ▶ Keyboard adapter kit compatible with Perpetual 30", 36" rectangles, 30", 36" concave, oval tables and PC3672(?).
- ▶ Full size center drawer is compatible with all Perpetual Rectangle tables and PC3672(?).
- ▶ Meets or exceeds ANSI/BIFMA and ISTA performance standards.

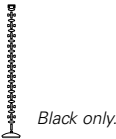
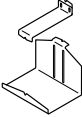
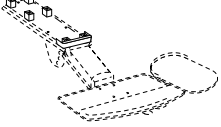
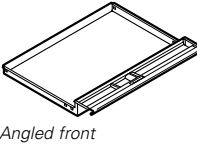
	Description	Model	Ship Weight	Cube	List
	Spacers and Glides Four Pack NOTE: Converts mobile tables to freestanding. • Specify paint color — Platinum Metallic (T1) only.	PGLIDE	5	0.1	\$ 96
	Ganging Brackets Table Top Ganging NOTES: Specify paint Charcoal (S). <i>Charcoal only.</i>	PGANG	1.1 S	0.03	\$ 50
	Wire Management Trays 72" 66" 60" 48" 42" 36" • Specify paint color — Platinum Metallic (T1) only. NOTE: Attaches to underside of worksurface with screws provided. Includes tray and two conduit clips. Not for use with Nesting Tables.	PWT72 PWT66 PWT60 PWT48 PWT42 PWT36	12 9 S 8 S 7 S 6 S 5 S	0.8 0.7 0.7 0.5 0.5 0.4	\$ 210 \$ 195 \$ 178 \$ 163 \$ 145 \$ 128
	Wire Management Vertical - 48" NOTE: Overall height is 39½"H. Weighted base measures 7/8" Dia. x 5/16"H. Width of spine is 3/8" thick. Specify: PWV.X — Black only. Not for use on nesting tables.	PWV	4 S	0.17	\$ 163
	CPU Holder Attaches to inside or outside of table legs. NOTE: Supports up to 30 pounds. • Specify paint color — Platinum Metallic (T1) only. • For use on Rectangular and Concave Tables and Returns only. Not for use on nesting tables.	PCPU	12 S	1.0	\$ 243
	Keyboard Adapter Kit NOTE: Consists of mounting blocks and decorative end cap to maintain Perpetual aesthetics. Order keyboards separately, shown on pages 466-468. Not for use with 840000 or HKB800. Not required for use with corners.	PKBRDAC	2 S	0.2	\$ 35
	Center Drawer (19"W x 21"D x 3¾"H) • Ball bearing slide suspension. • 12" drawer extension (3/4). • Inside drawer dimension: 19"W x 11¾"D x 1¾"H. • Minimum clearance for mounting: 21¾"W x 21"D. • Core removable lock. • Specify paint color — Platinum Metallic (T1) only.	PCNTRDRW	12 S	2.0	\$ 165

GSA — Above model receives Initiate Panel System discounting.

GSA — Above model receives Initiate Panel System discounting.

ONE KEY Refer to page 463

NOTE: Back section of center drawer is 1¾"H to fit under Perpetual cross-bars. Intended for use on Perpetual desks ONLY.

S Shippable by small-package carrier.

SPECIFY: Model.Paint (Platinum Metallic (T1))

EXAMPLE: PGLIDE.T1

index accessories education tables storage & files seating systems desking

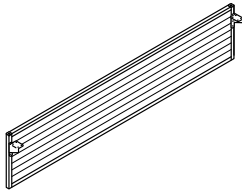

- ▶ Modesty panels consist of an extruded aluminum frame surrounding a translucent twin wall which attaches to rectangle and concave tables.
- ▶ Twin wall is a high performance, light-weight polycarbonate and comes standard in white.
- ▶ To be used with Tables, Returns, Bridges and Corner Units.
- ▶ Meets or exceeds ANSI/BIFMA and ISTA performance standards.

Desk Mounted Modesty Panels

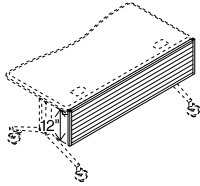

Description	Model	Ship Weight	Cube	List
Modesty Panel for 72"W Table, 12"H	PM1272	15	1.9	\$ 431
Modesty Panel for 66"W Table, 12"H	PM1266	13	1.7	\$ 415
Modesty Panel for 60"W Table, 12"H	PM1260	13	1.7	\$ 398
Modesty Panel for 48"W Table, 12"H	PM1248	12	1.3	\$ 368

NOTE: 7/8" Thick.



Mounting Bracket for Table Unit and Corner Unit Modesty Panel	PMCB	2 S	0.1	\$ 47
---	-------------	---	-----	-------

NOTE: Required for mounting two Modesty Panels on a Corner Unit or Table Unit.

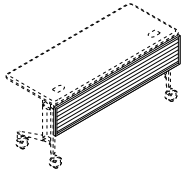

Modesty Panel for 60"W Nesting Table, 12"H	PM1260N	13	1.7	\$ 398
Modesty Panel for 48"W Nesting Table, 12"H	PM1248N	12	1.3	\$ 368

NOTE: Nesting tables shown on page 397.

S Shippable by small-package carrier.

SPECIFY: Model.Color

EXAMPLE: PM1272.X

To Order:

1. Determine which electrical system you will use after consulting your electrician and computer support personnel:
 - **The Four-circuit system (4-Hot/2-Neutral/2-Ground)**
 - 3 + 1 option
 - 2 + 2 option
 - **The Three-circuit system (3-Hot/3-Neutral/2-Ground)**
 2. Determine location, quantity and circuit of duplexes.
 3. Determine the appropriate choice and use of Isolated, Isolated/Dedicated and Separate Neutral circuits.
 4. Specify appropriate Power Harnesses* and Jumper Cables.*
 5. Determine the location, quantity and type of Power In-feed needed.
- * Select Power Harness models (ULHXX) and Jumper Cables (ULJCX).

Electrical System Options

The four-circuit, eight-wire electrical system is widely specified and trusted by hundreds of thousands of end-users. This proven system delivers four circuits for every power infeed in either a 3 + 1 or 2 + 2 configuration. The isolated/dedicated circuits are ideal for sensitive computing equipment, while the common circuits are suitable for faxes, copiers, task lights and other peripherals. Both the 3 + 1 and

2 + 2 systems use the same pre-wired components, making it easy to adjust as electrical needs change.

You can also choose a three-circuit, eight-wire system that has a dedicated neutral for every hot circuit. The three-circuit components have model numbers with an "A" suffix and appear in a gray box in this pricer.

Two 8-wire, 20 AMP (15 AMP Canadian) electrical systems are offered					
Electrical System	Circuitry	Receptacle Capacity			
Four-circuit 4-Hot/2-Neutral/2-Ground (10 gauge neutral wires)	3 + 1	Common Circuit-1 ULDC14	Common Circuit-2 (1) ULDC24	Common Circuit-3 ULDC34	Iso/Dedicated Circuit-4 ULDC44
	2 + 2	Common Circuit-1 ULDC14	Common Circuit-2 ULDC24	Isolated Circuit-3 ULDC64	Isolated Circuit-4 ULDC44
Three-circuit 3-Hot/3-Neutral/2-Ground (12 gauge neutral wires)	w/separate neutrals	Common Circuit-1 ULDC14A	Common Circuit-2 ULDC24A	Iso/Dedicated Circuit-3 ULDC34A	N/A

Notes:

- Four-circuit components and three-circuit components (with suffix "A") cannot be used together.
- Components of the two systems are keyed differently to prevent components of one system from being connected to components of another system.
- HON Cat. Nos. are printed on the UL labels, and components are color-coded to provide visual identification of the different components.
- Four-circuit components have black plastic parts.
- Three-circuit components have rust-colored terminal ends and receptacle backs are rust colored.

(1) Circuit-2 (one of the 3 common circuits sharing a neutral wire) cannot be used with a single-phase building electrical supply.

Typical power usage by the most commonly specified office equipment.

Source: Industry Analysis, Inc., Rochester, NY

EQUIPMENT	AMPS	EQUIPMENT	AMPS	EQUIPMENT	AMPS
Computers		Copiers		FAX Machines	
Personal Computer	3	Desktop Copier	15	InkJet FAX	less than 1
Notebook Computer	2	Console Copier	20	Thermal FAX	less than 1
		Copier/Duplicator	30	Plain paper FAX	8
Monitors		Printers		Task Lights	
13" Color Monitor	2	Dot Matrix	less than 1	36" T8 Fluorescent	0.2/bulb
17" Color Monitor	3	InkJet	less than 1	48" T8 Fluorescent	0.3/bulb
21" Color Monitor	4	Personal Laser or LED	8		
15" Plasma Monitor5	Workgroup Laser or LED	15		
20" Plasma Monitor	1				

Duplex Receptacles

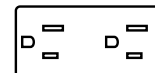

15 AMP Receptacle

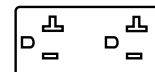

20 AMP Receptacle
(Required by some large copiers.)

index accessories education storage & files seating systems desks

- ▶ **NEW!** Platinum Metallic paint option for Power Management Tray.
- ▶ Electrical components are UL Listed and CSA Certified.
- ▶ For use with PR or PB models only. Cannot be used with Nesting Tables.
- ▶ For use on 48"W and 60"W tables in 24"D and 30"D sizes with casters or glides.
- ▶ 48"W and 60"W, 18"D may be used with glides only.
- ▶ It is the customer's responsibility to ensure that the use of pre-wired electrical system, the number of receptacles used on a given circuit, and connection to a building power source be in compliance with all local and national electrical codes.
- ▶ A licensed electrician must make connections to a building electrical supply.
- ▶ Electrically connected tables must be mechanically connected using HON Model PGANG Connector Kit — see page 400.
- ▶ Contact Customer Service for additional information.
- ▶ Four-circuit components and Three-circuit components (with suffix "A") can not be used together.
- ▶ Electrical can only be used on in-line table configurations, not in "LL", "L" or back-to-back layouts.

Maximum Receptacle Capacity

Table Widths	48	60
Maximum of 2 duplexes per table	X	
Maximum of 4 duplexes per table		X

NOTE: There is a maximum of 13 duplexes to a circuit.

Description	Model	Ship Weight	Cubes	List
Power Management Tray for 48"W Tables for 60"W Tables	PWTE48	22	3.4	\$ 364
	PWTE60	26	4.0	\$ 392

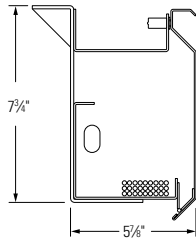
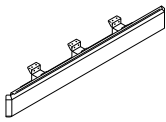

Cross Sectional View of Power Raceway

NOTES: Available in Platinum Metallic (T1) only. For use on Perpetual Tables and Desks only. Not compatible with HON Initiate electrical systems or Initiate and 38000 Series Desks. Will not fit Perpetual Desking with Modesty Panels.

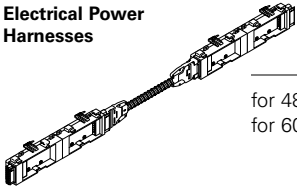
Electrical Power Harnesses	Max. Recept. Cap. per Table	Four-circuit 3 + 1 2 + 2	Three-circuit, Separate Neutrals	Ship Weight	Cubes	List
 for 48"W Tables for 60"W Tables	2	ULH48	ULH48A	3.0 [S]	0.5	\$ 185
	4	ULH60	ULH60A	3.0 [S]	0.5	\$ 232

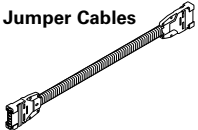
Jumper Cables 	Connects power harnesses Jumper Cable for in-line table-to-table connection (24"L).	ULJC24	ULJC24A	1.5 [S]	0.2	\$ 83
---	--	---------------	----------------	---------	-----	-------

Power In-Feed Cables 	Power In-Feed Cable (72" long conduit) (Sealtight Cable — 7/8" diameter) Connects Table to Power Entry Plate.	ULF6	ULF6A	4.0 [S]	0.3	\$ 123
--	--	-------------	--------------	---------	-----	--------

	Rotating Power Entry Plate	ULP4	ULP4A	1.5 [S]	0.2	\$ 83
---	----------------------------	-------------	--------------	---------	-----	-------

Black only

Duplex Receptacles  Each marked with Circuit Number Black only	Circuit 1	ULDC14	ULDC14A	1.0 [S]	0.5	\$ 27
	Circuit 2	ULDC24	ULDC24A	1.0 [S]	0.5	\$ 27
	Circuit 3 (except 2 + 2)	ULDC34	ULDC34A	1.0 [S]	0.5	\$ 27
	Circuit 4 — isolated, dedicated circuit	ULDC44		1.0 [S]	0.5	\$ 27
	Circuit 1 — (20 amp outlet configuration)	ULDC54	ULDC54A	1.0 [S]	0.5	\$ 27
	Circuit 3 — (2 + 2)	ULDC64		1.0 [S]	0.5	\$ 27

[S] Shippable by small-package carrier.

SPECIFY: Model.Color (if applicable)
Model.Paint (Platinum Metallic (T1))

EXAMPLES: PWTE48.P
PWTE48.T1

- ▶ Tercero, the office furniture series designed for complete conference room solutions.
- ▶ Table top shapes and sizes combine to meet the needs of any size conference or training room.
- ▶ Table bases are engineered to provide minimal leg interference.
- ▶ Uniquely designed exterior columns provide an exclusive and similar look to furniture accessories.
- ▶ Black comfort edge tops provide accessory furniture with a rich look and design.

Table Finish Selection

“G” 2MM Matching Edge Treatment: (Choosing “G” Edge Treatment top finish will match edge treatment).

Woodgrain Laminate: Bourbon Cherry (H), Henna Cherry (J), Mahogany (N), Medium Oak (M), Natural Maple (D)

Solid: Black (P), Charcoal (S), Light Gray (Q)

Patterned: Graphite (G3), Gray (G2), White (G1)

Ordering Example: **TC514G.H** Model(Edge).Laminate (In this example laminate top dictates matching edge treatment)

“V” Comfort Edge Treatment: (Laminate Top and Edge are one matching piece).

Woodgrain Laminate: Bourbon Cherry (H), Natural Maple (D)

Solid: Black (P), Light Gray (Q)

Ordering Example: **TC514V.H** Model.Laminate

Base Paint for Bases

Single Color: (leg and feet color match) Black (P), Titanium (C)

Finish Selection for Video Console, Mobile Audio Visual Cabinet, Presentation Cabinet and Adjustable Height Podium

Panel Laminate (Includes sides, doors, backs and shelves where applicable):

Woodgrain Laminate: Bourbon Cherry (H), Henna Cherry (J), Mahogany (N), Medium Oak (M), Natural Maple (D)

Solid: Black (P), Charcoal (S), Light Gray (Q)

Patterned: Graphite (G3), Gray (G2)

Paint for Tube Supports: Black (P), Titanium (C)

NOTE: Panel laminate surfaces have matching edge colors.

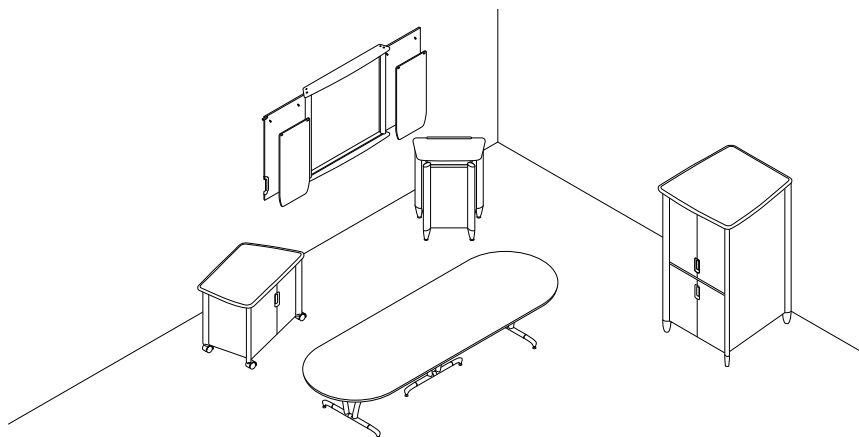

desking
systems
seating
storage & files
tables
education
accessories
index

Model numbers must be ordered individually. Other configurations are possible, including various sizes and additional components.

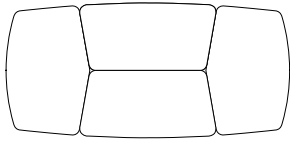

Trapezoid
120"L x 56³/₄"W

Qty.	Model #	Description
2	TC5G	Pentagon Shaped Top 55"L x 35 ¹ / ₂ "W
2	TC510G	Trapezoid Shaped Top 58 ³ / ₈ "L x 28 ³ / ₈ "W
4	BT02	Half-arch Leg Base 2 pack – 28 ³ / ₈ "H

List Price	Price Extension
\$ 435	\$ 870
\$ 367	\$ 734
\$ 332	\$ 1,328
TOTAL:	\$ 2,932



Rectangular
162¹/₂"L x 67"W

Qty.	Model #	Description
2	TCR6G	Half-ellipse Shaped Top 67"L x 35 ¹ / ₂ "W
2	TCR614G	Rectangular Shaped Top 95 ¹ / ₂ "L x 33 ¹ / ₂ "W
2	BT062	Half-arch Leg Base 2 pack – 28 ³ / ₈ "H
2	BT063	Half-arch Leg Base 3 pack – 28 ³ / ₈ "H

List Price	Price Extension
\$ 462	\$ 924
\$ 611	\$ 1,222
\$ 332	\$ 664
\$ 490	\$ 980
TOTAL:	\$ 3,790

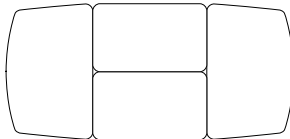

Rectangular
118"L x 56"W

Qty.	Model #	Description
2	TCR5G	Half-ellipse Shaped Top 56"L x 35 ¹ / ₂ "W
2	TCR510G	Rectangular Shaped Top 47 ¹ / ₂ "L x 28"W
4	BT02	Half-arch Leg Base 2 pack – 28 ³ / ₈ "H

List Price	Price Extension
\$ 421	\$ 842
\$ 313	\$ 626
\$ 332	\$ 1,328
TOTAL:	\$ 2,796

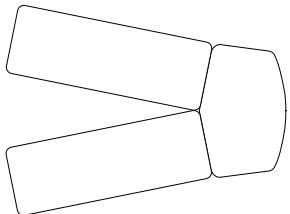

Video Conference
106"L x 84"W

Qty.	Model #	Description
1	TC5G	Pentagon Shaped Top 55"L x 35 ¹ / ₂ "W
2	TCR512G	Rectangular Shaped Top 71 ¹ / ₂ "L x 28"W
3	BT02	Half-arch Leg Base 2 pack – 28 ³ / ₈ "H

List Price	Price Extension
\$ 435	\$ 435
\$ 408	\$ 816
\$ 332	\$ 996
TOTAL:	\$ 2,247

Tercero™ Laminate Conference Tops

GSA SIN 711-11

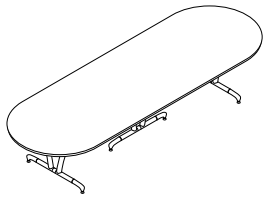









- ▶ Comfort edge tops are 1½" thick MDF vacuum formed with a membrane press application of rigid vinyl edgeband.
- ▶ Tops available in "V", Comfort Edge, only.
- ▶ All tables are 29½"H.
- ▶ Bases and tops ordered separately and shipped in separate cartons. ETA.
- ▶ Underside of tops are sealed to resist warping.
- ▶ Leg Bases shown on page 408.
- ▶ See chart below to determine base configuration requirements for selected top size.
- ▶ Meets or exceeds ANSI/BIFMA and ISTA performance standards.

Edge Treatment



"V" Comfort Edge
(Will match laminate selection.)

	Description	Model	Ship Weight	Cube	List
Rectangular Shaped Laminate Tops 	120"L x 48"W	TCC120V	260	17.5	\$ 1314
	96"L x 48"W	TCC96V	210	14.1	\$ 1125
E  A					
Racetrack Shaped Laminate Tops 	120"L x 48"W	TCA120V	255	17.5	\$ 1354
	96"L x 48"W	TCA96V	215	14.1	\$ 1150
E  A					
Boat Shaped Laminate Tops 	120"L x 48"W	TCB120V	245	17.5	\$ 1354
	96"L x 48"W	TCB96V	200	14.1	\$ 1150
E  A					
Round Laminate Tops 	48" diameter	TCD48V	85	7.8	\$ 585
	42" diameter	TCD42V	70	5.7	\$ 557
E  A					

Tercero™ Conference Tables			Number of Base Models required:
Shapes Available	Top Dimensions	Seating Capacity	Half-arch Base
Rectangle, Racetrack, Boat	120"L x 48"W	10	3 — BTL01
Rectangle, Racetrack, Boat	96"L x 48"W	8	2 — BTL01
Round	48"	5	1 — BTR04
Round	42"	4	1 — BTR04
Bases per Kit			1

NOTE See page 408 for Leg Base Information.

E  A Easy to assemble.

SPECIFY: Model.Laminate

EXAMPLES: TCC144V.H

Edge Treatments:



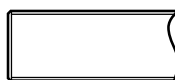





- HOW TO ORDER
 1) Select desired model numbers.
 2) Select desired top edge treatment.
 3) Replace the (?) after each model number with the suffix representing the chosen top edge treatment.



"G" 2MM Matching
(Color must be selected.)

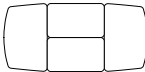

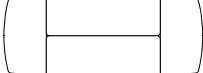
"V" Comfort Edge
(Will match laminate selection.)

	Description	Model	Ship Weight	Cube	List by Edge Treatment	
					"G"	"V"
Pentagon Shaped Laminate Tops 	50"-55"L x 35½"W NOTE: Designed to be used with Trapezoid models E◆A TC514(?), TC512(?), TC510(?) shown below.	TC5(?)	75	6.5	\$ 435	\$ 678
Trapezoid Shaped Laminate Tops 	97"-106⅝"L x 29½"W 73"-82⅝"L x 28⅞"W 49"-58⅝"L x 28⅞"W E◆A 	TC514(?) TC512(?) TC510(?)	112 90 65	10.0 7.8 5.5	\$ 557 \$ 489 \$ 367	\$1057 \$ 881 \$ 732
Half-ellipse Shaped Laminate Tops 	56"L x 35½"W NOTE: Designed to be used with Rectangular models E◆A TCR514(?), TCR512(?), TCR511(?), TCR510(?) shown below.	TCR5(?)	83	6.9	\$ 421	\$ 678
Rectangular Shaped Laminate Tops 	95½"L x 28"W 71½"L x 28"W 58½"L x 28"W 47½"L x 28"W E◆A 	TCR514(?) TCR512(?) TCR511(?) TCR510(?)	104 83 70 62	9.2 7.0 5.5 4.7	\$ 516 \$ 408 \$ 367 \$ 313	\$ 937 \$ 802 \$ 705 \$ 597
Half-ellipse Shaped Laminate Tops 	67"L x 35½"W NOTE: Designed to be used with Rectangular models E◆A TCR614(?), TCR612(?), TCR611(?), TCR610(?) shown below.	TCR6(?)	95	8.2	\$ 462	\$ 937
Rectangular Shaped Laminate Tops 	95½"L x 33½"W 71½"L x 33½"W 58½"L x 33½"W 47½"L x 33½"W E◆A 	TCR614(?) TCR612(?) TCR611(?) TCR610(?)	132 104 87 70	10.9 8.2 6.5 5.6	\$ 611 \$ 462 \$ 450 \$ 408	\$ 990 \$ 876 \$ 774 \$ 673
	Ganging Hardware for TC and TCR Series Tables	TCE650	2 	0.13	\$ 40	

Tercero™ Conference Tables			Number of Base Models required:
Shapes Available	Top Dimensions	Seating Capacity*	Half-Arch Base
Pentagon (TC5?)	55"L x 35½"W	2	1 — BT02
Trapezoid (TC514?)	106"L x 29½"W	4	1 — BT03
Trapezoid (TC512?)	82"L x 28⅞"W	3	1 — BT02
Trapezoid (TC510?)	58"L x 28⅞"W	2	1 — BT02
Half-ellipse (TCR5?)	56"L x 35½"W	2	1 — BT02
Rectangular (TCR514?)	95½"L x 28"W	4	1 — BT03
Rectangular (TCR512?)	71½"L x 28"W	3	1 — BT02
Rectangular (TCR511?)	58½"L x 28"W	2	1 — BT02
Rectangular (TCR510?)	47½"L x 28"W	2	1 — BT02
Half-ellipse (TCR6?)	67"L x 35½"W	2	1 — BT062
Rectangular (TCR614?)	95½"L x 33½"W	4	1 — BT063
Rectangular (TCR612?)	71½"L x 33½"W	3	1 — BT062
Rectangular (TCR611?)	58½"L x 33½"W	2	1 — BT062
Rectangular (TCR610?)	47½"L x 33½"W	2	1 — BT062
Bases per Carton			2/3**

* Seating capacity reflects sitting at one side of table. See page 408 for Leg Base information.

** See page 408 for carton quantities.

 Shippable by small-package carrier.

E◆A Easy to assemble.

SPECIFY: Model (Edge).Laminate

EXAMPLE: TC5G.H

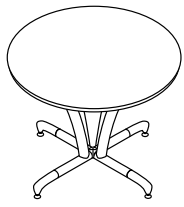

- ▶ Bases and tops ordered separately and shipped in separate cartons. ETA.
- ▶ Bases feature adjustable leveling glides.
- ▶ Tables with bases are 29½"H.
- ▶ Bases attach to tops with hardware provided, no drilling is required. Pilot holes are pre-drilled for ease of assembly.
- ▶ See charts on pages 406 and 407 to determine base configuration requirements for selected top size.
- ▶ BTL01 and BTR04 bases can be used with the veneer conference tables on page 388, and the 10500 Series edge table tops on page 132.
- ▶ Models BTL01 and BTR04 have adjustable leveling glides.
- ▶ Models BT02, BT062, BT03 and BT063 bases have adjustable leveling glides on users side and 2" dual-wheel casters on approach side.
- ▶ Meets or exceeds ANSI/BIFMA and ISTA performance standards.

	Description	Model	Ship Weight	Cube	List
	Half-arch Leg Base (2 per carton) Single color (leg and feet color match). NOTE: Specify Black (P) or Titanium (C).	BT02	23	4.5	\$ 332
		BT062	23	4.5	\$ 332
	Half-arch Leg Base (3 per carton) Single color (leg and feet color match). NOTE: Specify Black (P) or Titanium (C).	BT03	35	6.0	\$ 490
		BT063	35	6.0	\$ 490
	Half-arch Leg Base (1 per carton) Single color (leg and feet color match). NOTE: Specify Black (P). Cannot be used with 60"L x 30"W Rectangular table tops.	BTL01	21	2.1	\$ 359
	Half-arch Leg Base (1 per carton) Single color (leg and feet color match). NOTE: Specify Black (P).	BTR04	44	24.0	\$ 582

NOTE See pages 406 and 407 for Leg Base Information.



Easy to assemble.

SPECIFY: Model.Paint

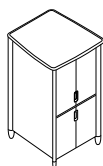
EXAMPLE: BT02.P

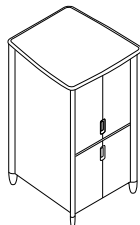
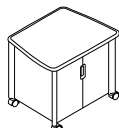
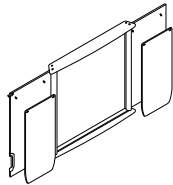

- ▶ Tops are standard with Comfort Thermoform Edge made of a vacuum formed membrane press application of rigid PVC vinyl over MDF. Finish selection is Black (P) only (no ordering code required).
- ▶ Specify laminate for edges of panels, sides, doors, backs and shelves where applicable – see page 404.
- ▶ Tube supports for all models are available in Black (P) and Titanium (C) only.
- ▶ Mobile AV Cabinet and Hospitality Cart require casters to be attached.
- ▶ Arched door handle area is standard with Titanium/Black color finish.
- ▶ Meets or exceeds ANSI/BIFMA and ISTA performance standards.

	Description	Model	Ship Weight	Cube	List
 <p>Video Console</p>	<ul style="list-style-type: none"> • Ships partially assembled. • Accommodates up to 32" diagonal monitors. • Upper cabinet comes complete with pocket doors which provide for unobstructed viewing. • Lower cabinet includes 2 adjustable and removable interior shelves. • Shelves adjust at 2½" increments. Interior storage to easily accommodate peripheral equipment. • Perforated rear panels for venting and cable management. • Overall cabinet dimensions 46"W x 33"D x 78"H. • Lower and upper cabinet Trapezoidal inside dimensions measure 37¼"W at the front, tapering to 33¾"W at the rear. • Lower and upper cabinet door opening measures 37¼"W. • Equipped with HON "one key" interchangeable core-removable locks. 	TCE260	375	87.0	\$3471
E T A					
 <p>Mobile Audio Visual Cabinet</p>	<ul style="list-style-type: none"> • Ships partially assembled. • Top and bottom shelves are Black thermoform only (no ordering code required). • 36½"H for unobstructed view. Top surface accommodates up to 36" diagonal monitors. • Lower cabinet includes 1 adjustable and removable interior shelf. Shelf adjusts at 2½" increments. Interior storage to easily accommodate peripheral equipment. • Perforated rear panel for venting and cable management. • Overall cabinet dimensions 39½"W x 29½"D x 36½"H (with casters). • Cabinet is configured in a trapezoidal shape. Front of cabinet measures 33¾"W with door opening of 29½"W • Trapezoidal inside dimensions measure 29½" at the front tapering to 25½" at the rear. • Lockable doors with magnetic touch latch. • Equipped with HON "one key" interchangeable core-removable locks. • 4" casters, 2-locking, 2-non-locking. 	TCE230	160	30.0	\$1926
E T A					
 <p>Presentation Cabinet</p>	<ul style="list-style-type: none"> • Ships fully assembled. • Top and bottom are Black thermoform only (no ordering code required). • Overall cabinet dimensions 50¾"W x 6½"D x 48½"H. • Cabinet opens to reveal a 48"W x 48"H non-ghosting acrylic writing surface. Inside doors have a markerboard surface measuring 23"W x 45"H. • Inside of each door accommodates a 21"W x 40¾"H lightweight removable markerboard. • Provides almost 50 square feet of dry erase writing surface. • Can accommodate removable paper tablets. Mounts underneath removable markerboard. Accommodates standard sizes 20" x 23" and 22" x 25". 	TCE315	178	13.1	\$2227
E T A					
	<ul style="list-style-type: none"> • Optional 44"W Projection screen available for presentation cabinet. Seamless, pull down and retractable projection screen perfect for all LCD and overhead presentations. Frame is Black only. 	TCE335	12	1.4	\$ 233
E T A					
 <p>Adjustable Height Podium</p>	<ul style="list-style-type: none"> • Ships partially assembled. • Adjustable height podium accommodates multiple presenters with easy adjustment mechanism. • Height easily adjusts from 39"H to 49"H. • Front, back and sides constructed of ¾" thick solid core high pressure particleboard. • Podium measures 27¼"W x 17"D x 46"H. • Presenter worksurface measures 32" x 20½". • Front Stationary portion of podium is 37½"H. • Back stationary portion of podium is 32¾"H. 	TCE115	103	16.5	\$1838
E T A					

E T A Easy to assemble.

SPECIFY: Model.Panel Laminate/Tube Support Paint/Laminate Edge

EXAMPLE: TCE260.HPH

desking

systems

seating

storage & files

tables



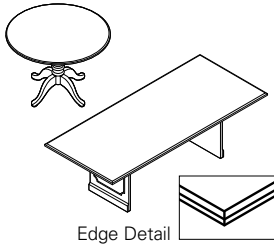

education

accessories

index

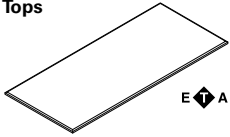

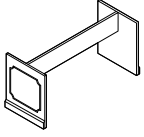
- ▶ Design matches 94000 Series Laminate Desks. See pages 136-140.
- ▶ Classic traditional styling.
- ▶ Bases and tops ordered separately and shipped in separate cartons.
- ▶ Tops with bases are 29½"H.
- ▶ Tops feature premium abrasion- and stain-resistant high pressure laminate over durable 1⅝" solid core high-performance particleboard.
- ▶ Tops designed with elegant traditional edge profile on all sides.
- ▶ Slab bases feature traditional-styled decorative molding.
- ▶ Rectangular tops require two or three Queen Anne base units or one slab base unit.
- ▶ All bases feature adjustable leveling glides.
- ▶ Available in Mahogany (N).
- ▶ Meets or exceeds ANSI/BIFMA and ISTA performance standards.

	Description	Model	Ship Weight	Cube	List
Tops  	Rectangular Shaped Laminate Top 120"L x 48"W (ships in two pieces)	94612	210	11.0	\$1945
	96"L x 42"W	94696	155	8.9	\$1362
	72"L x 36"W	94672	105	5.8	\$ 779
	Round Laminate Top 48" diameter	94448	64	5.2	\$ 709
	42" diameter	IN STOCK 94442	45	4.1	\$ 619
Base Kits  	Laminate Slab Base Kit for 120"L Top	94016	88	7.0	\$ 609
	Laminate Slab Base Kit for 96"L Top	94015	78	5.2	\$ 589
	Laminate Slab Base Kit for 72"L Top	94014	73	5.0	\$ 540
	Queen Anne Base Kit	IN STOCK 94011	40	5.4	\$ 499
	NOTES: 3 kits are required for 120"L rectangular top. 2 kits are required for 96"L or 72"L rectangular tops. 1 kit required for 48" or 42" diameter round tops. NOTES: Must use specified base size and quantity for each top size. Base includes adjustable leveling glides.				
Laminate Cylinder Base 	Laminate Cylinder Base	BLCY02	37	11.6	\$ 442
		BLCY01	30	8.3	\$ 399
	NOTES: 2 BLCY02 bases are required for 96"L rectangular top. 2 BLCY01 bases are required for 72"L rectangular top. 1 BLCY02 base is required for 48" and 42" diameter tops. NOTES: Cylinder base requires 150 pounds of sand or other ballast in each base for stability (Customer to supply). Ballast permits smaller diameter base resulting in added kneespace.				

IN STOCK See page 1.
E A Easy to assemble.

SPECIFY: Model.Laminate

EXAMPLE: 94612.N

Table Finish Selection

Woodgrain Laminate: Bourbon Cherry (H), Henna Cherry (J), Mahogany (N), Medium Oak (M), Natural Maple (D)
Solid: Blue (B6), Charcoal (S), Green (B5), Light Gray (Q), Parchment (K2), Red (B1), Whitestone (K4), and Yellow (B2)
Patterned: Bronze Legacy (L3), Carbon Evolv (L1), Graphite (G3), Gray (G2), Grey Tigris (L6), White (G1)

T-Mold Edge Treatment (Models 1109-1157): Black (P), Charcoal (S), Henna Cherry (J), Light Gray (Q), Mahogany (N), Medium Oak (M), Natural Maple (D)
 Ordering Example: **1109.A9P** Model.Laminate/Edge

2MM Matching Edge (Models 1309-1357): Bourbon Cherry (H), Charcoal (S), Graphite (G3), Gray (G2), Henna Cherry (J), Light Gray (Q), Mahogany (N), Medium Oak (M), Natural Maple (D)
 Ordering Example: **1309.M** Model.Laminate (In this example laminate top dictates matching edge treatment)

Comfort Edge (Laminate Top Finish and Edge Treatment MATCH) (Models 1320V-1323V) *Comfort Edge: Must choose from the following:* Light Gray (Q), Mahogany (N), Medium Oak (M), Natural Maple (D)
 Ordering Example: **1320V.M** Model.Laminate

Hospitality Table/Base Specifying Information

Laminate Top Size	Base Option Model Numbers
Square Tops	
24"L x 24"W	BBX22, BCR22
30"L x 30"W	BBX22, BCR22, XSP-26
36"L x 36"W	BBX36, RSPBASE, XSP-26, BCR28
42"L x 42"W	BBX40, XSP-36
Round Tops	
24" dia.	BBX22, BCR22, BCR22BH, BCR22FR
30" dia.	BBX22, BCR22, BCR22BH, BCR22FR, XSP-26
36" dia.	BBX36, BCR22, BCR28BH, BCR28FR, RSPBASE, XSP-26
42" dia.	BBX36, BCR28, BCR28BH, BCR28FR, XSP-36
48" dia.	BBX40, XFP-36
Rectangular Shaped Tops	
48"L x 24"W	T-20B
60"L x 24"W	T-20B
72"L x 24"W	T-20B
96"L x 24"W	T-26B, BMX01 (must order two bases per top, see pages 391 and 393)
48"L x 30"W	T-26B
60"L x 30"W	T-26B
72"L x 30"W	T-26B
96"L x 30"W	T-26B, BMX01 (must order two bases per top, see pages 391 and 393)
72"L x 36"W	T-26B
96"L x 36"W	T-26B, BMX01 (must order two bases per top, see pages 391 and 393)

index accessories education tables storage & files seating systems desking

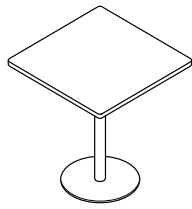

- ▶ Choice of edge – T-mold, 2MM matching and Comfort.
- ▶ Square and rectangle tops with T-mold edge have 1"R corners.
- ▶ Square and rectangle tops with Chamfer and 2MM edges have 3"R corners.
- ▶ 1½" thick laminate top.
- ▶ Minimum 45 lbs. industrial grade substrate.
- ▶ Tops and bases are ordered separately and shipped in separate cartons.
- ▶ See page 412 for top/base availability.
- ▶ Order bases separately see pages 414-415.
- ▶ Comfort edge tops are 1½" thick MDF with a vacuum formed membrane press application of rigid PVC vinyl over MDF.
- ▶ Meets or exceeds ANSI/BIFMA and ISTA performance standards.

Laminate Top Size	T-mold Edge		2MM Matching Edge		Comfort Edge		Ship Weight	Cubes
Square Tops E A								
24"L x 24"W	1109	\$ 164	1309	\$ 177			28 [S]	2.1
30"L x 30"W	1110	\$ 178	1310	\$ 232			36 [S]	4.5
36"L x 36"W	1111	\$ 193	1311	\$ 254			51 [S]	4.5
42"L x 42"W	1112	\$ 237	1312	\$ 308			69	8.0
Round Tops E A								
24" dia.	1119	\$ 152	1319	\$ 177			28 [S]	2.1
30" dia.	1120	\$ 178	1320	\$ 232	1320V	\$ 329	28 [S]	2.3
36" dia.	1121	\$ 193	1321	\$ 254	1321V	\$ 452	40 [S]	2.3
42" dia.	1122	\$ 234	1322	\$ 308	1322V	\$ 597	55	3.1
48" dia.	1123	\$ 268	1323	\$ 326	1323V	\$ 715	71	4.1
Rectangular Shaped Tops E A								
48"L x 24"W	1133	\$ 193	1333	\$ 245			45 [S]	4.0
60"L x 24"W	1134	\$ 239	1334	\$ 299			57 [S]	5.0
72"L x 24"W	1135	\$ 273	1335	\$ 320			68	6.0
96"L x 24"W	1137	\$ 351	1337	\$ 398			94	8.0
48"L x 30"W	1143	\$ 241	1343	\$ 264			57 [S]	5.0
60"L x 30"W	1144	\$ 275	1344	\$ 304			71	6.3
72"L x 30"W	1145	\$ 326	1345	\$ 380			85	7.5
96"L x 30"W	1147	\$ 435	1347	\$ 502			114	10.0
72"L x 36"W	1155	\$ 353	1355	\$ 421			102	7.5
96"L x 36"W	1157	\$ 466	1357	\$ 528			137	10.0

[S] Shippable by small-package carrier.







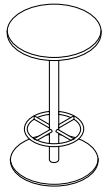



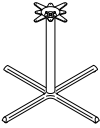

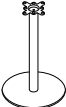

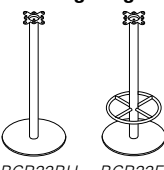
E A Easy to assemble.

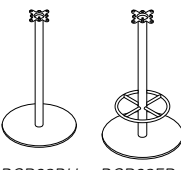
SPECIFY: Model.Laminate
Model.Laminate/Edge

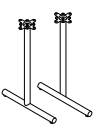

EXAMPLES: 1320V.M
1109.N.P

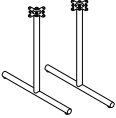

- ▶ Model BCR28BH is 28" diameter round base, 41"H standing height base.
- ▶ Model BCR28FR is 28" diameter round base, 41"H standing height base with foot ring.
- ▶ Self-adjusting table base glides eliminate table wobble. Adjusts to any uneven floor surface up to 1/2" by using tables own weight.
- ▶ Template underside of top facilitates base attachment. Bases are attached with self drilling screws, no drilling is required.
- ▶ See page 415 for additional base options.
- ▶ See pages 412-413 for top options.
- ▶ Meets or exceeds ANSI/BIFMA and ISTA performance standards.

Base Kits  A	Description	Model	Ship Weight	Cube	List Core
	22" x 22" base	BBX22	21 	2.5	\$ 113
	36" x 36" base	BBX36	36 	3.7	\$ 181
	40" x 40" base	BBX40	60	3.2	\$ 318
	NOTE: Black (P) only.				
	22" dia. round base	BCR22	44 	2.5	\$ 208
	28" dia. round base	BCR28	63	2.5	\$ 399
	NOTE: Black (P) only.				
	22" dia. round base	BCR22BH	(column) 7  (base) 30 	0.2 0.9	\$ 237
	NOTES: Shipped in two cartons. 41"H standing height base. Black (P) only.				
	22" dia. round base with 19" dia. welded foot ring	BCR22FR	52	14.0	\$ 318
	NOTES: Ships in one carton. 41"H standing height base. Black (P) only.				
	28" dia. round base	BCR28BH	(column) 7  (base) 71 	0.3 3.3	\$ 431
	NOTES: Shipped in two cartons. 41"H standing height base. Accommodates 36" and 42" dia. round tops. Black (P) only.				
	28" dia. round base with 19" dia. welded foot ring	BCR28FR	(column) 17  (base) 71 	9.0 3.3	\$ 501
	NOTES: Shipped in two cartons. 41"H standing height base. Accommodates 36" and 42" dia. round tops. Black (P) only.				
	20"W T-base (2 per carton)	T-20B	24 	0.5	\$ 331
	NOTE: Black (P) or Chrome (CHR) finish.				
	26"W T-base (2 per carton)	T-26B	26 	0.5	\$ 374
	NOTE: Black (P) or Chrome (CHR) finish.				

NOTE: See pages 412-413 for base applications.



 A Easy to assemble.
 Shippable by small-package carrier.

SPECIFY: Model.Base Finish

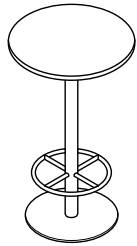
EXAMPLE: BBX22.P

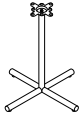
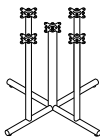
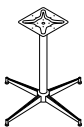

- ▶ Attachment hardware included.
- ▶ Adjustable leveling floor glides.
- ▶ Bases and tops shipped in separate cartons.
- ▶ All table bases measure 27¾"H without top, 29"H with top except models BCR22BH and BCR22FR; 41"H without top, 42"H with top.
- ▶ See page 414 for additional base options.
- ▶ See pages 412-413 for top options.
- ▶ Meets or exceeds ANSI/BIFMA and ISTA performance standards.

Base Kits E A	Description	Model	Ship Weight	Cube	List Core
3"Dia. Single Column 	26" x 26" base	XSP-26	17 S	1.2	\$ 305
	36" x 36" base	XSP-36	26 S	2.3	\$ 409
NOTE: Black (P) or Chrome (CHR) finish.					
Five Column 	36" x 36" base	XFP-36	54 S	2.7	\$ 620
NOTES: 3" dia. center column with four 2" dia. vertical columns. Black (P) or Chrome (CHR) finish.					
Four Prong 	32" x 32" Chrome base	RSPBASE	14 S	2.1	\$ 188
NOTES: 3" dia. center column. Chrome (CHR) only.					
Accessories  <small>BLG4</small>  <small>BLG5</small>	Self-leveling glides (package of 4). Black (P) only.	BLG4	1 S	0.1	\$ 34
	Self-leveling glides (package of 5). Black (P) only.	BLG5	1 S	0.1	\$ 42

NOTE: See pages 412-413 for base applications.

E A Easy to assemble.
S Shippable by small-package carrier.

SPECIFY: Model.Base Finish

EXAMPLE: XSP-26.P

deskings systems seating storage & files tables education accessories index

Training Tables Ordering Information

This page contains specifying information for pages 418-435.



Training Table Finishes

		Activity Tables	Education Workstations	Essential Foundations®	61000 Series ©	The StationMaster® ©	Utility Tables	Adjustable Computer Desks
LAMINATES		CODES						
CORE	Bourbon Cherry	H	•		•	•		
	Columbian Walnut	Z	•		•	•		
	Henna Cherry	J	•		•	•	•	
	Mahogany	N	•		•	•	•	•
	Shaker Cherry	F	•			•	•	
WOOD GRAN	Medium Oak	M	•	•	•	•	•	•
	Natural Maple	D	•	•	•	•	•	
SOLID	Black	P				•		
	Blue	B6	•	•				
	Charcoal	S	•			•	•	
	Green	B5	•	•				
	Light Gray	Q	•	•	•	•	•	•
	Parchment	K2	•	•	•	•	•	
	Red	B1	•	•				
	Whitestone	K4	•	•	•	•	•	
	Yellow	B2	•	•				
PATTERNED	Bronze Legacy	L3	•	•	•	•		
	Carbon Evolv	L1	•	•	•	•		
	Canyon Zephyr NEW!	K9	•			•	•	
	Cloud Zephyr NEW!	K7	•			•	•	
	Desert Zephyr NEW!	K8	•			•	•	
	Morro Zephyr NEW!	L9	•			•	•	
	Shadow Zephyr NEW!	K1	•			•	•	
	Graphite	G3	•	•	•	•	•	•
	Gray	G2	•	•	•	•	•	•
	Grey Tigris	L6	•	•	•	•	•	
	White	G1	•	•		•	•	

NOTE: Laminate selection on the Modesty Panels for Education Workstations is limited to Light Gray (Q), Medium Oak (M) and Natural Maple (D).

See page 13 for laminates that are still available through January 3, 2009.

index accessories education tables storage & files seating systems desking

Training Table Finishes

		Activity Tables	Education Workstations	Essential Foundations®	61000 Series ©	The StationMaster® ©	Laminate Table Desk	Utility Tables	Adjustable Computer Desks
PAINTS		CODES							
CORE	Black	P	•	•	•	•		•	•
	Carob NEW!	T8			•	•			
	Charcoal	S		•	•	•		•	•
	Greige NEW!	T5			•	•			
	Light Gray	Q	•	•	•	•		•	•
	Muslin	T3			•	•			
	Putty	L		•	•	•		•	•
	Taupe	E				•	•		
	Tan D D	V				•			
METALLIC	Champagne Metallic NEW!	T4			•	•			
	Platinum Metallic NEW!	T1			•	•			
T-MOLD		CODES							
	Black	P	•	•		•			•
	Charcoal	S	•			•			•
	Henna Cherry	J	•						
	Light Gray	Q	•	•		•			•
	Mahogany	N	•						
	Medium Oak	M	•	•					•
	Natural Maple	D	•	•					
BEADED T-MOLD		CODES							
	Black	P		•					
	Charcoal	S		•					
	Light Gray	Q		•					
1/2 MIL EDGE BAND		CODES							
	Black	P	•						
	Light Gray	Q	•						
	Medium Oak	M	•						
	Natural Maple	D	•						

**1/2 mil edge band colors available only on Modesty Panels for Education Workstations.

desking systems seating storage & files tables education accessories index

© Core Product Line
D D Discontinued 12/26/2009.

Activity Tables

GSA SIN 711-11

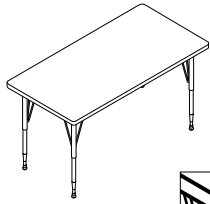

Edge Detail



- ▶ Tops are high pressure laminate over 1 1/8" thick solid core high-performance particleboard.
- ▶ Tops and legs are packaged and shipped separately, ETA.
- ▶ Leg assembly: Upper frame is painted Black, lower leg is Chrome. Bottom of leg assembly equipped with nylon glides. Leg assemblies attach to top with six included wood screws.
- ▶ Pilot holes are pre-drilled for easy leg placement and assembly.
- ▶ Legs available in the following sizes/finishes:
 - "L" – Long Black/Chrome upper frame black, lower leg is chrome, adjusts in 1" increments from 20"-29"H
 - "S" – Short Black/Chrome upper frame black, lower leg is chrome, adjusts in 1" increments from 14 1/2"-20 1/2"H
 - "LC" – Long Chrome All-chrome leg, adjusts in 1" increments from 20"-29"H
- ▶ Models ESR3060(?), ESR3072(?), ESR3660(?), ESR3672, ESK4872(?) and ESH6066(?) include stretcher bars for added strength.
- ▶ Meets or exceeds ANSI/BIFMA and ISTA performance standards.

	Description	Top Size	Model	Ship		List Price by Height		
				Weight	Cube	"L"	"S"	"LC"
 E A	Rectangle Top	72"W x 36"D	ESR3672(?)	102	8.2	\$ 398	\$ 392	\$ 412
		60"W x 36"D	ESR3660(?)	85	6.9	\$ 370	\$ 364	\$ 384
		72"W x 30"D	ESR3072(?)	85	7.0	\$ 349	\$ 343	\$ 363
		60"W x 30"D	ESR3060(?)	71	6.3	\$ 310	\$ 304	\$ 324
		48"W x 30"D	ESR3048(?)	57	5.0	\$ 262	\$ 256	\$ 276
		48"W x 24"D	ESR2448(?)	45	4.0	\$ 248	\$ 242	\$ 262
		36"W x 24"D	ESR2436(?)	35	3.0	\$ 228	\$ 222	\$ 242
 E A	Trapezoid Top	60"W x 30"D	EST3060(?)	61	6.9	\$ 335	\$ 329	\$ 349
		NOTES: Leading edge: 30 1/2"W. Rear edge: 59 1/2"W. Front to back: 26 1/4"D.						
 E A		48"W x 24"D	EST2448(?)	35	3.5	\$ 262	\$ 256	\$ 276
		NOTES: Leading edge: 24 1/2"W. Rear edge: 47 1/2"W. Front to back: 21"D.						
 E A	Round Top	48" Diameter	ESD48(?)	71	4.3	\$ 356	\$ 350	\$ 370
		42" Diameter	ESD42(?)	55	5.7	\$ 327	\$ 321	\$ 341
		36" Diameter	ESD36(?)	40	4.3	\$ 299	\$ 293	\$ 313
 E A	Square Top	48"W x 48"D	ESS48(?)	80	5.7	\$ 360	\$ 354	\$ 374
		36"W x 36"D	ESS36(?)	51	4.3	\$ 280	\$ 274	\$ 294
 E A	Kidney Top	72"W x 48"D	ESK4872(?)	118	10.6	\$ 546	\$ 540	\$ 560
 E A	Horseshoe Top	66"W x 60"D	ESH6066(?)	123	12.1	\$ 584	\$ 578	\$ 598

E A Easy to assemble.
 Shippable by small-package carrier.

SPECIFY: Model(Height).Laminate/T-mold

EXAMPLE: ESR3672L.HP

- ▶ Tops are high pressure laminate over 1½" thick solid core high-performance particleboard.
- ▶ Underside of tops are sealed to resist warping.
- ▶ Workstation is shipped disassembled. Easy to assemble.

- ▶ All workstations adjust in height from 22½" to 32½"H, adjustable in 1" increments. Legs are locked in place with screws. Hex wrench provided.
- ▶ Model CAST/S4 adds 4" height to workstation.
- ▶ Plastic leveling glides provide ½" adjustability with a base diameter of 1".
- ▶ Workstations meet American Disabilities Act requirements for wheelchair accessibility.

- ▶ 18"D workstations do not accept keyboard platforms.
- ▶ 36" & 48"W workstations are designed to accommodate one 4022, 4028, 4029 or DLKP keyboard platform only.
- ▶ 60" & 72"W workstations will only accommodate keyboard platform model DLKP.
- ▶ 72"W and 84"W models require EDKBRDAC Adapter Kit if installing DLKP Keyboard Platform or CPU2 CPU holder.

- ▶ Workstations accommodate 60999 easy connector kit for ganging of workstations.
- ▶ The 24" and 30"D edges of the Trapezoid tops do not work together in ganging or group applications due to the clearance of the legs. These models are designed to group with the rectangular models. Two Trapezoid tops may be ganged along the 48" and 60"W edges.

- ▶ Trapezoid sizes use 48" and 36"W wire management trays.
- ▶ Wire management trays are available for 36", 48", 60", & 72"W rectangle workstations.
- ▶ Models EDB3672G and EDB3660G are standard with two wire management trays.
- ▶ Grommets standard in Black.
- ▶ Meets or exceeds ANSI/BIFMA & ISTA performance standards.



	Description	Model	Ship Weight	Cube	List	
Rectangular Tops with Grommets 	72"W x 24"D x 22½"-32½"H Workstation (2 grommets)	ED2472G	102	8.2	\$ 465	
	60"W x 24"D x 22½"-32½"H Workstation (2 grommets)	ED2460G	88	6.9	\$ 403	
	48"W x 24"D x 22½"-32½"H Workstation (1 grommet)	ED2448G	74	5.2	\$ 374	
	36"W x 24"D x 22½"-32½"H Workstation (1 grommet)	ED2436G	60	4.1	\$ 362	
	E A					
	72"W x 30"D x 22½"-32½"H Workstation (2 grommets)	ED3072G	114	10.1	\$ 498	
	60"W x 30"D x 22½"-32½"H Workstation (2 grommets)	ED3060G	100	8.5	\$ 435	
	48"W x 30"D x 22½"-32½"H Workstation (1 grommet)	ED3048G	84	6.8	\$ 393	
	36"W x 30"D x 22½"-32½"H Workstation (1 grommet)	ED3036G	71	5.2	\$ 380	
	E A					
	72"W x 36"D x 22½"-32½"H Workstation (4 grommets)	EDB3672G	125	10.5	\$ 951	
	60"W x 36"D x 22½"-32½"H Workstation (4 grommets)	EDB3660G	118	10.1	\$ 802	
NOTES: Dual-sided workstations, user can be positioned on either side allowing up to four users. Includes two wire management trays. Accommodates model DLKP keyboard platform.						
E A						
Rectangular Tops without Grommets 	84"W x 18"D x 22½"-32½"H Workstation (no grommets)	ED1884N	88	9.6	\$ 574	
	72"W x 18"D x 22½"-32½"H Workstation (no grommets)	ED1872N	79	8.2	\$ 462	
	60"W x 18"D x 22½"-32½"H Workstation (no grommets)	ED1860N	70	6.9	\$ 397	
	48"W x 18"D x 22½"-32½"H Workstation (no grommets)	ED1848N	66	5.2	\$ 373	
	NOTE: 18"D workstations do not accept keyboard platforms.					
	E A					
	72"W x 24"D x 22½"-32½"H Workstation (no grommets)	ED2472N	102	8.2	\$ 444	
	60"W x 24"D x 22½"-32½"H Workstation (no grommets)	ED2460N	88	6.9	\$ 378	
	48"W x 24"D x 22½"-32½"H Workstation (no grommet)	ED2448N	74	5.2	\$ 355	
	36"W x 24"D x 22½"-32½"H Workstation (no grommet)	ED2436N	60	4.1	\$ 341	
	E A					
	72"W x 30"D x 22½"-32½"H Workstation (no grommets)	ED3072N	114	10.1	\$ 469	
	60"W x 30"D x 22½"-32½"H Workstation (no grommets)	ED3060N	100	8.5	\$ 404	
	48"W x 30"D x 22½"-32½"H Workstation (no grommet)	ED3048N	84	6.8	\$ 373	
	36"W x 30"D x 22½"-32½"H Workstation (no grommet)	ED3036N	71	5.2	\$ 357	
	E A					
	Trapezoid Tops 	60"W x 30"D x 22½"-32½"H Trapezoid Workstation (1grommet)	EDT3060G	100	8.5	\$ 517
		NOTES: Leading edge: 30½"W. Rear edge: 59½"W. Front to back: 26¼"D. Use model EDWWM48 Wire Management Tray — see page 421.				
E A						
48"W x 24"D x 22½"-32½"H Trapezoid Workstation (1 grommet)	EDT2448G	67	5.2	\$ 466		
NOTES: Leading edge: 24½"W. Rear edge: 47½"W. Front to back: 21"D. Use model EDWWM36 Wire Management Tray — see page 421.						

NOTE: See page 421 for Education Workstation Accessories.

Wheel-chair compatible.
 Easy to assemble.

SPECIFY: Model.Laminate/Paint/T-mold

EXAMPLE: ED2472G.MPP

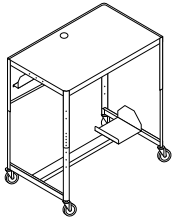

- ▶ Sit/Stand Workstation adjusts from 27"-41"H.
- ▶ Standard with CPU holder and cord management tray.
- ▶ Workstations meet American Disabilities Act requirements for wheelchair accessibility.
- ▶ Modesty panels are constructed of 3/4" thick melamine with a 1/2 mil vinyl edge band.
- ▶ Modesty panels are NOT designed to be used with Power Raceway models ULP36, ULP48, ULP60 and ULP72.
- ▶ Modesty panels shown fit on Education Workstations shown on page 419.
- ▶ Modesty panels can be used in conjunction with cord management trays EDWM36, EDWM48, EDWM60 and EDWM72.
- ▶ Grommets standard in Black.
- ▶ Meets or exceeds ANSI/BIFMA and ISTA performance standards.

index accessories education storage & files seating systems desking

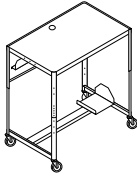

Description	Model	Ship Weight	Cube	List
Mobile Computer Sit/Stand Workstation <ul style="list-style-type: none"> • Worksurface adjusts from 27"H-41"H in two inch increments. • Height adjustment at 27", 29", 31", 33", 35", 37", 39" and 41"H. • Worksurface measures 37"W x 22½"D. • Worksurface standard with non-skid rubber mat. • Modesty panel features an integrated cord management tray. • Modesty panel measures 37"W x 4"H x 1½"D. • 4" casters, two locking. • Adjustable CPU holder that mounts to the left or right of the table frame. • CPU holder adjusts from 6½"-11¼"W. EDA • Available in Mist Gray N1 only.	EDC41J	61	17.9	\$ 520

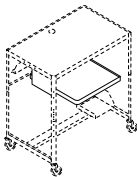

Metal Keyboard Shelf <ul style="list-style-type: none"> • Shelf measures 20"W x 18"D, with 1/8" rounded lip on the edge. • Keyboard shelf attaches to the underside of model EDC41J worksurface. • Two brackets mount to underside of worksurface through pre-drilled holes. • Available in Mist Gray N1 only.	EDPOS	14	S 2.2	\$ 276
---	-------	----	-------	--------

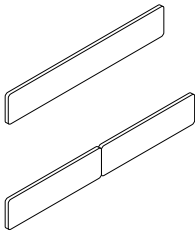

Modesty Panels (Packaged 1 to a carton) <ul style="list-style-type: none"> 36"W x 10"H 48"W x 10"H 60"W x 10"H 72"W x 10"H 84"W x 10"H NOTE: 72" and 84"W models are two-piece panels. Modesty panels for use on Education workstations on page 419. Laminate selection limited to Light Gray (Q), Medium Oak (M) and Natural Maple (D).	EDM36S EDM48S EDM60S EDM72S EDM84S	14 16 19 22 25	S S S S S	0.9 1.1 1.4 1.1 1.2	\$ 185 \$ 212 \$ 263 \$ 290 \$ 316
--	--	----------------------------	-----------------------	---------------------------------	--

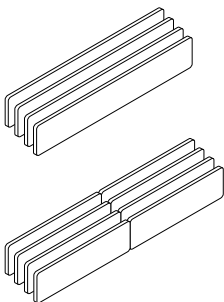

Bulk-Pack Modesty Panels (Packaged 4 to a carton) <ul style="list-style-type: none"> 36"W x 10"H 48"W x 10"H 60"W x 10"H 72"W x 10"H 84"W x 10"H NOTES: 72" and 84"W models are two-piece panels. Bulk pack modesty panels are ordered and shipped four (4) panels per carton . Pricing shown is per carton . Each set of four (one carton), must be the same color. Ordering 2 of Model EDM36B will result in 2 cartons being shipped, giving you 8 modesty panels. 72" and 84"W models are two-piece panels. Modesty panels for use on Education workstations on page 419. Laminate selection limited to Light Gray (Q), Medium Oak (M) and Natural Maple (D).	EDM36B EDM48B EDM60B EDM72B EDM84B	38 47 56 68 86	S S S S S	2.1 2.3 3.3 2.7 3.1	\$ 736 \$ 841 \$1049 \$1156 \$1261
--	--	----------------------------	-----------------------	---------------------------------	--

NOTE: See page 421 for Education Workstation Accessories.

Wheel-chair compatible.
 EDA Easy to assemble.
 Shippable by small-package carrier.

SPECIFY: Model.Paint
Model.Laminate/Edge

EXAMPLES: EDC41J.N1
EDM36S.MP

- ▶ Model CAST/S4 adds 4" height to workstation.
 - ▶ Caster option CAST/S2 will increase overall height of workstations by 2".
 - ▶ Meets or exceeds ANSI/BIFMA & ISTA performance standards.
- ▶ Wire Management Tray dimensions:
 EDWM724"H x 2½"D x 57⅞"L
 EDWM604"H x 2½"D x 45⅞"L
 EDWM484"H x 2½"D x 33⅞"L
 EDWM364"H x 2½"D x 21⅞"L

	Description	Model	Ship Weight	Cube	List
	Wire Management Tray for 72"W Rectangular Workstation	EDWM72*	10.5 [S]	1.0	\$ 124
	Wire Management Tray for 60"W Rectangular Workstation	EDWM60	9 [S]	0.8	\$ 112
	Wire Management Tray for 48"W Rectangular and Trapezoid Workstation	EDWM48	6.5 [S]	0.6	\$ 101
	Wire Management Tray for 36"W Rectangular and Trapezoid Workstation	EDWM36	5 [S]	0.4	\$ 88

NOTES: Attaches to underside of worksurface with screws provided.
 End caps of tray each include 1" dia. wire grommet.
Available in Black (P) or Light Gray (Q) only.
 * When used with Education Workstation 72"W or 84"W modesty panels, you must order two (2) EDWM36 as those modesty panels come in two pieces.

	Four 2" swivel casters — 2 locking, 2 non-locking For use with Education Workstations on page 419. Will increase height of table 2". Available in Black (P) only.	CAST/S2	1 [S]	0.1	\$ 43
---	---	----------------	-------	-----	-------

Black only

	Four 4" swivel casters — 2 locking, 2 non-locking For use with Education Workstations on page 419. Will increase height of table 4". Available in Black (P) only.	CAST/S4	4 [S]	0.3	\$ 73
---	---	----------------	-------	-----	-------

Black only

	Sliding Keyboard Tray, 21½"W x 10¼"D <ul style="list-style-type: none"> • Clearance for keyboards up to 2.75" in height. • Minimum clearance for mounting: 20"W x 15½"D. • Fits all Education Workstations and 61000 Series Tables. • Must use Adapter Kit EDKBRDAC when mounting to 72" and 84"W Education Workstations, except for Dual-sided worksurfaces to accommodate for stiffener on underside of table. • Black only (P) laminate specification color code required. 	DLKP	10 [S]	0.7	\$ 193
---	--	-------------	--------	-----	--------

Black only

	CPU Tower Holder Metal Clamp Bracket NOTES: Attach to inside or outside of adjustable leg. Available in Black (P) only. Can be used on Education Workstations ONLY.	EDCPM	4 [S]	0.3	\$ 126
---	--	--------------	-------	-----	--------

Black only

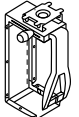
	CPU Holder <ul style="list-style-type: none"> ▶ Black Finish <ul style="list-style-type: none"> • Supports up to 85 lbs. • Height adjustable from 15" to 24" below worksurface. • Width adjustable to accept units from 3" to 9"W. • Must use Adapter Kit EDKBRDAC when mounting to 72" and 84"W Education Workstations except for dual-sided workstations. • Must mount inside unit only. 	CPU2	7.5 [S]	0.5	\$ 132
---	--	-------------	---------	-----	--------

Black only

SIN 711-1, 711-2

GSA — Above model receives Initiate Panel System discounting.

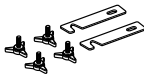
	Easy Connector Kit For quick connection of rectangular-shaped desks to rectangular-shaped desks. NOTE: Includes 4 knobs and 2 hooks.	60999	0.5 [S]	0.1	\$ 37
---	--	--------------	---------	-----	-------

Black only

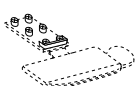
	Keyboard Adapter Kit for 72" and 84"W Workstation NOTES: Consists of mounting blocks and decorative end cap to maintain aesthetics. Order DLKP keyboards separately. For use with 72" and 84"W Education Workstation (except for dual-sided workstations), 72"W 61000 Series Tables. Allows attachment of DLKP, CPU2 and CPU3.	EDKBRDAC	2 [S]	0.2	\$ 32
---	--	-----------------	-------	-----	-------

NOTE: See pages 419 and 420 for Education Workstations.

[D] Discontinued 12/26/2009.
[S] Shippable by small-package carrier.

SPECIFY: Model.Paint

EXAMPLE: EDWM72.P

EDUCATION WORKSTATION HARDWARE SOLUTION

To Order:

1. Determine which electrical system you will use after consulting your electrician and computer support personnel:
 - **The Four-circuit system (4-Hot/2-Neutral/2-Ground)**
 - 3 + 1 option
 - 2 + 2 option
 - **The Three-circuit system (3-Hot/3-Neutral/2-Ground)**
 2. Determine location, quantity and circuit of duplexes.
 3. Determine the appropriate choice and use of Isolated, Isolated/Dedicated and Separate Neutral circuits.
 4. Specify appropriate Power Harnesses* and Jumper Cables.*
 5. Determine the location, quantity and type of Power In-feed needed.
- * Select Power Harness models (ULHXX) and Jumper Cables (ULJCX).

Electrical System Options

The four-circuit, eight-wire electrical system is widely specified and trusted by hundreds of thousands of end-users. This proven system delivers four circuits for every power infeed in either a 3 + 1 or 2 + 2 configuration. The isolated/dedicated circuits are ideal for sensitive computing equipment, while the common circuits are suitable for faxes, copiers, task lights and other peripherals. Both the 3 + 1 and

2 + 2 systems use the same pre-wired components, making it easy to adjust as electrical needs change.

You can also choose a three-circuit, eight-wire system that has a dedicated neutral for every hot circuit. The three-circuit components have model numbers with an "A" suffix and appear in a gray box in this pricer.

Two 8-wire, 20 AMP (15 AMP Canadian) electrical systems are offered					
Electrical System	Circuitry	Receptacle Capacity			
Four-circuit 4-Hot/2-Neutral/2-Ground (10 gauge neutral wires)	3 + 1	Common Circuit-1 ULDC14	Common Circuit-2 (1) ULDC24	Common Circuit-3 ULDC34	Iso/Dedicated Circuit-4 ULDC44
	2 + 2	Common Circuit-1 ULDC14	Common Circuit-2 ULDC24	Isolated Circuit-3 ULDC64	Isolated Circuit-4 ULDC44
Three-circuit 3-Hot/3-Neutral/2-Ground (12 gauge neutral wires)	w/separate neutrals	Common Circuit-1 ULDC14A	Common Circuit-2 ULDC24A	Iso/Dedicated Circuit-3 ULDC34A	N/A

Notes:

- Four-circuit components and three-circuit components (with suffix "A") cannot be used together.
- Components of the two systems are keyed differently to prevent components of one system from being connected to components of another system.
- HON Cat. Nos. are printed on the UL labels, and components are color-coded to provide visual identification of the different components.
- Four-circuit components have black plastic parts.
- Three-circuit components have rust-colored terminal ends and receptacle backs are rust colored.

(1) Circuit-2 (one of the 3 common circuits sharing a neutral wire) cannot be used with a single-phase building electrical supply.

Typical power usage by the most commonly specified office equipment.

Source: Industry Analysis, Inc., Rochester, NY

EQUIPMENT	AMPS	EQUIPMENT	AMPS	EQUIPMENT	AMPS
Computers		Copiers		FAX Machines	
Personal Computer	3	Desktop Copier	15	InkJet FAX	less than 1
Notebook Computer	2	Console Copier	20	Thermal FAX	less than 1
		Copier/Duplicator	30	Plain paper FAX	8
Monitors		Printers		Task Lights	
13" Color Monitor	2	Dot Matrix	less than 1	36" T8 Fluorescent	0.2/bulb
17" Color Monitor	3	InkJet	less than 1	48" T8 Fluorescent	0.3/bulb
21" Color Monitor	4	Personal Laser or LED	8		
15" Plasma Monitor5	Workgroup Laser or LED	15		
20" Plasma Monitor	1				

Duplex Receptacles



15 AMP Receptacle

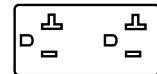

20 AMP Receptacle
(Required by some large copiers.)

index accessories education tables storage & files seating systems desking

EDUCATION WORKSTATION HARDWARE SOLUTION

- ▶ Electrical components are UL Listed and CSA Certified.
- ▶ It is the customer's responsibility to ensure that the use of pre-wired electrical system, the number of receptacles used on a given circuit, and connection to a building power source be in compliance with all local and national electrical codes.
- ▶ A licensed electrician must make connections to a building electrical supply.
- ▶ Electrically connected tables must be mechanically connected in a straight line using HON Model 60999 Easy Connector Kit — see page 421.
- ▶ Electrical can only be used in "in-line" table configurations — not "U", "L" or back-to-back layouts.
- ▶ Contact Customer Service for additional information.
- ▶ Four-circuit components and Three-circuit components (with suffix "A") can not be used together. See pages 204-205.

Maximum Receptacle Capacity

Table Widths	36	48	60	72
Maximum of 2 duplexes per table		X	X	
Maximum of 4 duplexes per table			X	X

NOTE: There is a maximum of 13 duplexes to a circuit.

Description	Model	Ship Weight	Cubes	List	
Power Raceways 	for 36"W Tables — 35½"L x 5¼"D x 5"H	ULP36	12	1.0	\$ 339
	for 48"W Tables — 47½"L x 5¼"D x 5"H	ULP48	15	1.4	\$ 394
	for 60"W Tables — 59½"L x 5¼"D x 5"H	ULP60	19	1.7	\$ 459
	for 72"W Tables — 71½"L x 5¼"D x 5"H	ULP72	23	2.0	\$ 532

NOTES: Available in Black (P) only.
 For use on Education Workstations (24" and 30"D only) only.
 Not compatible with HON Initiate® electrical systems or Initiate and 38000 Series desks.

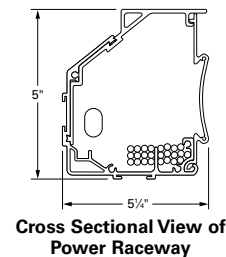

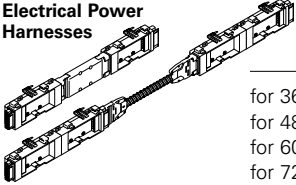
Electrical Power Harnesses	Max. Recept. Cap. per Table	Four-circuit 3 + 1 2 + 2	Three-circuit, Separate Neutrals	Ship Weight	Cubes	List	
	for 36"W Tables	2	ULH36	ULH36A	2.0 [S]	0.5	\$ 152
	for 48"W Tables	2	ULH48	ULH48A	3.0 [S]	0.5	\$ 185
	for 60"W Tables	4	ULH60	ULH60A	3.0 [S]	0.5	\$ 232
	for 72"W Tables	4	ULH72	ULH72A	4.0 [S]	0.5	\$ 245

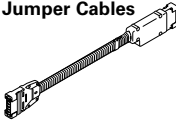
Jumper Cables 	Connects power harnesses Expandable Jumper Cable for table-to-table connection (20"L).	ULJC	ULJCA	1.5 [S]	0.2	\$ 83
---	---	-------------	--------------	---------	-----	-------

Power In-Feed Cables 	Power In-Feed Cable (72" long conduit) Connects Table to Power Entry Plate.	ULF6	ULF6A	4.0 [S]	0.3	\$ 123
--	--	-------------	--------------	---------	-----	--------

	Rotating Power Entry Plate	ULP4	ULP4A	1.5 [S]	0.2	\$ 83
---	----------------------------	-------------	--------------	---------	-----	-------

Black only

Duplex Receptacles	Circuit	Model	Model A	Ship Weight	Cubes	List
	Circuit 1	ULDC14	ULDC14A	1.0 [S]	0.5	\$ 27
	Circuit 2	ULDC24	ULDC24A	1.0 [S]	0.5	\$ 27
	Circuit 3 (except 2 + 2 — see below)	ULDC34	ULDC34A	1.0 [S]	0.5	\$ 27
	Circuit 4 — isolated, dedicated circuit	ULDC44		1.0 [S]	0.5	\$ 27
	Circuit 1 — (20 amp outlet configuration)	ULDC54	ULDC54A	1.0 [S]	0.5	\$ 27
	Circuit 3 — (2 + 2)	ULDC64		1.0 [S]	0.5	\$ 27

Each marked with Circuit Number

Black only

[S] Shippable by small-package carrier.

SPECIFY: Model.Color (if applicable)

EXAMPLE: ULP36.P

EDUCATION WORKSTATION SOFTWARE SOLUTION

Interlink Software Power Solution

- ▶ Single circuit power.
- ▶ 12 AMP system rating.
- ▶ 15 AMP power cord with 15 AMP over-current protection.
- ▶ Up to 8 duplex devices must be connected in sequence.

- ▶ 40 feet maximum total length.
- ▶ See page 425 for model specification.

Interlink Software Power Solution is an independent system not to be utilized with hardwire power systems on pages 422-423.

- ▶ UL Listed for use on Education Workstations table series.

Electrically connected tables must be mechanically connected using HON Model 60999 Easy Connector Kit — see page 421.

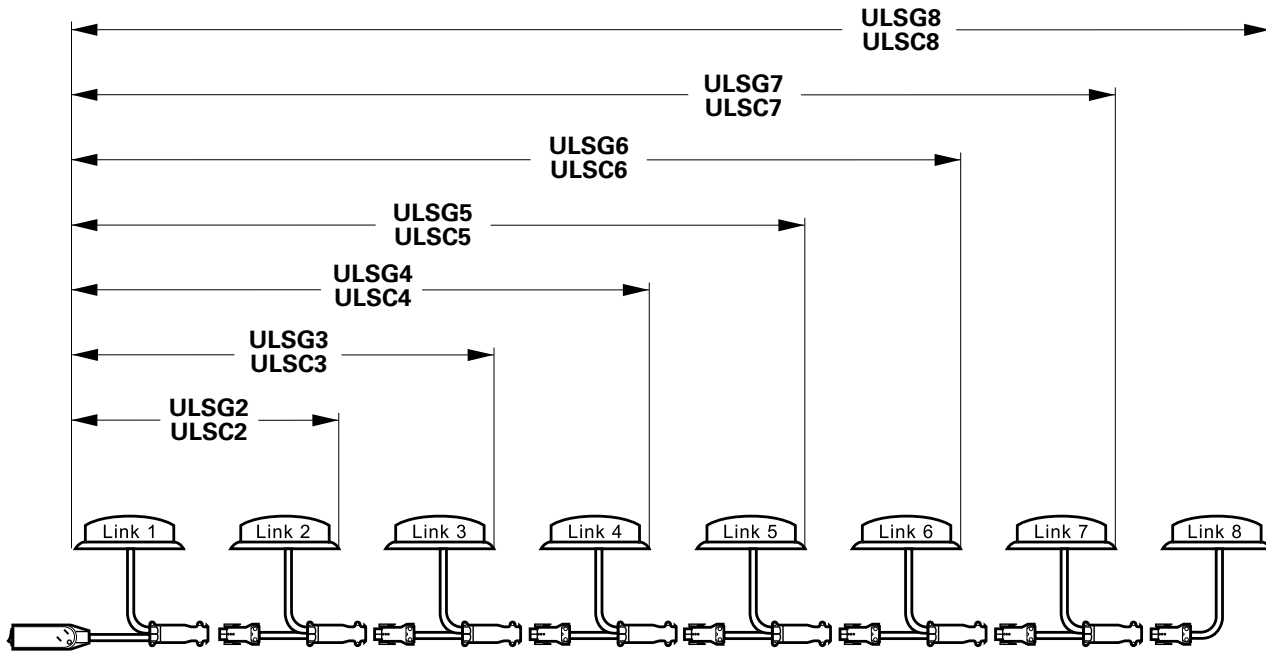

Description	Model	Link	Connects to
Starter Link – 1	ULSG1/ULSC1	Link 1 Black	Power Source
Add On Link – 2	ULSG2/ULSC2	Link 2 Black/Red	Link 1
Add On Link – 3	ULSG3/ULSC3	Link 3 Red/Blue	Link 2
Add On Link – 4	ULSG4/ULSC4	Link 4 Blue/Orange	Link 3
Add On Link – 5	ULSG5/ULSC5	Link 5 Orange/Yellow	Link 4
Add On Link – 6	ULSG6/ULSC6	Link 6 Yellow/Green	Link 5
Add On Link – 7	ULSG7/ULSC7	Link 7 Green/White	Link 6
Add On Link – 8	ULSG8/ULSC8	Link 8 White	Link 7

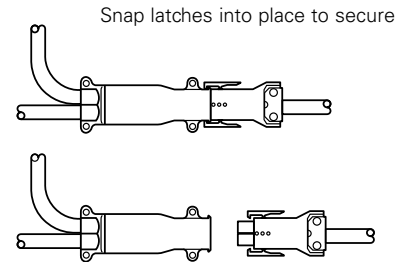

Depress latch to release.

EDUCATION WORKSTATION SOFTWARE SOLUTION

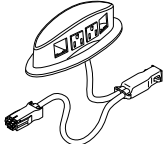
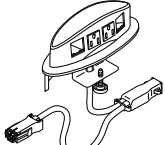
	Description	Model One-circuit	Ship Weight	Cube	List
 Black only	Interlink Software Power Solution - Grommet Style Grommet Style NOTES: Fits into worksurface grommet cut-outs. Provides two 15-amp simplex receptacles, two voice/data ports, voice/data adapter kit (to accept couplers and jacks; couplers and jacks not included.) and 6' long power cord.	ULSG1	2.0 S	0.2	\$ 231
	Includes Starter Link 1 (Black) and Link 2 (Black/Red)	ULSG2	4.0 S	0.2	\$ 448
	Includes Starter Link 1 (Black), Link 2 (Black/Red) and Link 3 (Red/Blue)	ULSG3	6.0 S	0.8	\$ 623
	Includes Starter Link 1 (Black), Link 2 (Black/Red), Link 3 (Red/Blue) and Link 4 (Blue/Orange)	ULSG4	7.0 S	0.8	\$ 798
	Includes Starter Link 1 (Black), Link 2 (Black/Red), Link 3 (Red/Blue), Link 4 (Blue/Orange) and Link 5 (Orange/Yellow)	ULSG5	8.0 S	0.8	\$ 972
	Includes Starter Link 1 (Black), Link 2 (Black/Red), Link 3 (Red/Blue), Link 4 (Blue/Orange), Link 5 (Orange/Yellow) and Link 6 (Yellow/Green)	ULSG6	11.0 S	1.7	\$1149
	Includes Starter Link 1 (Black), Link 2 (Black/Red), Link 3 (Red/Blue), Link 4 (Blue/Orange), Link 5 (Orange/Yellow), Link 6 (Yellow/Green) and Link 7 (Green/White)	ULSG7	12.0 S	1.7	\$1323
	Includes Starter Link 1 (Black), Link 2 (Black/Red), Link 3 (Red/Blue), Link 4 (Blue/Orange), Link 5 (Orange/Yellow), Link 6 (Yellow/Green), Link 7 (Green/White), and Link 8 (White/White)	ULSG8	13.0 S	1.7	\$1501
 Black only	Interlink Software Power Solution - Clamp-on Style Edge Mount Style NOTES: Attaches to worksurface with thumbscrew application. Provides two 15-amp simplex receptacles, two voice/data ports, voice/data adapter kit (to accept couplers and jacks; couplers and jacks not included.) and 6' long power cord.	ULSC1	2.0 S	0.4	\$ 243
	Includes Starter Link 1 (Black) and Link 2 (Black/Red)	ULSC2	5.0 S	0.4	\$ 475
	Includes Starter Link 1 (Black), Link 2 (Black/Red) and Link 3 (Red/Blue)	ULSC3	7.0 S	0.8	\$ 677
	Includes Starter Link 1 (Black), Link 2 (Black/Red), Link 3 (Red/Blue) and Link 4 (Blue/Orange)	ULSC4	8.0 S	0.8	\$ 880
	Includes Starter Link 1 (Black), Link 2 (Black/Red), Link 3 (Red/Blue), Link 4 (Blue/Orange) and Link 5 (Orange/Yellow)	ULSC5	10.0 S	0.8	\$1069
	Includes Starter Link 1 (Black), Link 2 (Black/Red), Link 3 (Red/Blue), Link 4 (Blue/Orange), Link 5 (Orange/Yellow) and Link 6 (Yellow/Green)	ULSC6	13.0 S	1.7	\$1258
	Includes Starter Link 1 (Black), Link 2 (Black/Red), Link 3 (Red/Blue), Link 4 (Blue/Orange), Link 5 (Orange/Yellow), Link 6 (Yellow/Green) and Link 7 (Green/White)	ULSC7	14.0 S	1.7	\$1433
	Includes Starter Link 1 (Black), Link 2 (Black/Red), Link 3 (Red/Blue), Link 4 (Blue/Orange), Link 5 (Orange/Yellow), Link 6 (Yellow/Green), Link 7 (Green/White), and Link 8 (White/White)	ULSC8	16.0 S	1.7	\$1593
Interlink Table Attachment System Includes 2 cable ties, 2 screws and 2 conduit clips	ULSA	0.1 S	0.1	\$ 11	

S Shippable by small-package carrier.

SPECIFY: Model.Color (if applicable)

EXAMPLE: ULSG1

Essential Foundations® Training Tables — Typicals

GSA SIN 711-2

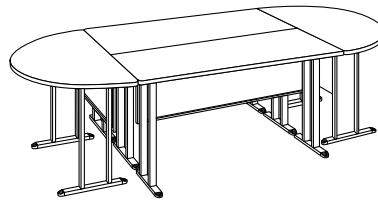
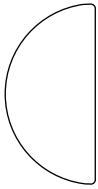
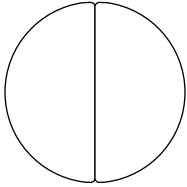
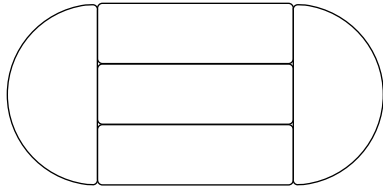

60"W 108"D

Half-Round/Rectangle
108"W x 60"D

Qty.	Model #	Description	List Price	Price Extension
2	5285	Half-round Top 60"W x 30"D x 29½"H	\$ 623	\$ 1,246
2	5263	Rectangle Top 48"W x 30"D x 29½"H	\$ 556	\$ 1,112
TOTAL:				\$ 2,358

Essential Foundations® Training Tables — Accessories

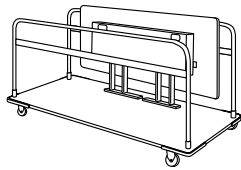

- ▶ Rubber bumper absorbs impact.
- ▶ Four dual wheel casters (2 locking, 2 non-locking).
- ▶ Holds 5 tables.
- ▶ Training tables measure 4¾" thick when folded.
- ▶ **Black only. Specify model number.**

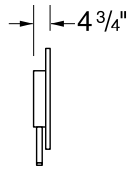

Model 5254
End View

Description	Model	Ship Weight	Cube	List
 <p>Table Truck 73¼"W x 30"D x 34"H</p>	5299	150	12.4	\$1549

SPECIFY: Model



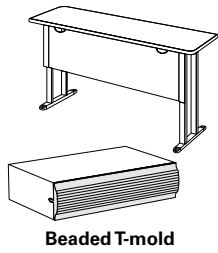

EXAMPLE: 5299

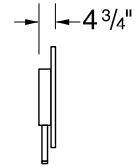

- ▶ Integrated carrying handles/wire management grommet in modesty panel makes transporting tables easy.
- ▶ Bases and top fold for storage using minimum space (4 3/4" thick when folded).
- ▶ Easy-to-use brackets keep tables connected and top surfaces even.
- ▶ Patent-pending mechanism locks legs in folded position.
- ▶ Ships fully assembled in folded position.
- ▶ High pressure laminate tops.
- ▶ Beaded design vinyl edges.
- ▶ Shipped one to a carton.
- ▶ Painted heavy-gauge steel bases and modesty panel.
- ▶ Adjustable leveling glides where applicable.
- ▶ Meets or exceeds ANSI/BIFMA and ISTA performance standards.

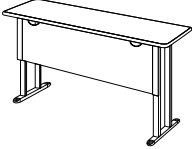

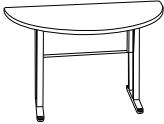
**Model 5254
End View**



Description	Model	Ship Weight	Cube	List
Rectangular Tops				
 48"W x 18"D x 29 1/2"H	5233	71	6.1	\$ 529
54"W x 18"D x 29 1/2"H	5230	76	6.1	\$ 548
60"W x 18"D x 29 1/2"H	5234	81	7.5	\$ 556
66"W x 18"D x 29 1/2"H	5236	86	7.5	\$ 602
72"W x 18"D x 29 1/2"H	5235	90	8.1	\$ 646
<hr/>				
48"W x 24"D x 29 1/2"H	5253	80	6.1	\$ 529
54"W x 24"D x 29 1/2"H	5250	85	6.1	\$ 570
60"W x 24"D x 29 1/2"H	5254	92	7.5	\$ 588
66"W x 24"D x 29 1/2"H	5256	98	7.5	\$ 623
72"W x 24"D x 29 1/2"H	5255	103	8.1	\$ 677
<hr/>				
48"W x 30"D x 29 1/2"H	5263	88	6.1	\$ 556
54"W x 30"D x 29 1/2"H	5260	95	6.1	\$ 588
60"W x 30"D x 29 1/2"H	5264	101	7.5	\$ 606
66"W x 30"D x 29 1/2"H	5266	109	7.5	\$ 638
72"W x 30"D x 29 1/2"H	5265	115	8.1	\$ 692
<hr/>				
Trapezoid Tops				
 54"W x 24"D x 29 1/2"H	5273	75	6.5	\$ 596
60"W x 30"D x 29 1/2"H	5275	85	8.0	\$ 628
<hr/>				
Half-round Tops				
 48"W x 24"D x 29 1/2"H	5283	70	6.5	\$ 573
60"W x 30"D x 29 1/2"H	5285	88	8.0	\$ 623
<hr/>				
Semi-circle Top				
 48"W x 24"D x 29 1/2"H	5293	75	6.5	\$ 569

61000 Series Training Tables

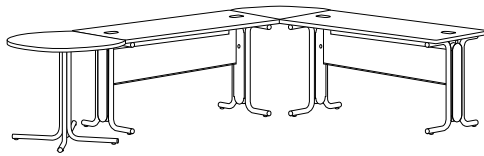
GSA SIN 711-2

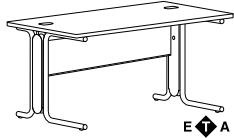
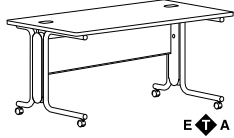
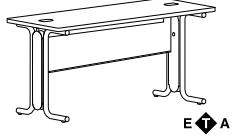
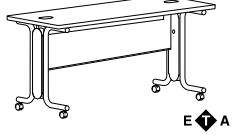

- ▶ **NEW!** Paint grade options.
- ▶ 1½" thick tops with T-Mold edge.
- ▶ Grommet color will match T-Mold selection.
- ▶ Models available with and without casters for maximum flexibility — 2 locking, 2 non-locking. All models are 29½"H.
- ▶ C-leg design contains a vertical wire management cavity with removable pass-through cover.
- ▶ Leveling glides provide ¾" maximum adjustability.
- ▶ Modesty panel features a horizontal wire management trough under the worksurface.
- ▶ 72"W models require EDKBRDAC Adapter Kit if installing DLKP Keyboard Platform or CPU2 CPU holder.
- ▶ Tables are shipped **E A** — Easy To Assemble.
- ▶ Meets or exceeds ANSI/BIFMA and ISTA performance standards.

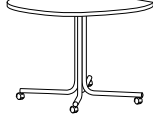
Description	Top Size	Model	Ship Weight	Cube	List by Paint Grade	
					Core	Metallics "2"
 Desk 29½"H	72"W x 30"D	61372	129	11.0	\$ 596	\$ 624
	60"W x 30"D	61360	113	9.2	\$ 536	\$ 561
	48"W x 30"D	61348	95	7.5	\$ 489	\$ 512
 Desk w/casters 29½"H	72"W x 30"D	61372C	129	11.0	\$ 633	\$ 663
	60"W x 30"D	61360C	113	9.2	\$ 578	\$ 606
	48"W x 30"D	61348C	95	7.5	\$ 528	\$ 552
 Desk 29½"H	72"W x 24"D	61272	116	9.1	\$ 551	\$ 577
	60"W x 24"D	61260	99	7.7	\$ 497	\$ 520
	48"W x 24"D	61248	88	5.7	\$ 448	\$ 469
 Desk w/casters 29½"H	72"W x 24"D	61272C	116	9.1	\$ 592	\$ 619
	60"W x 24"D	61260C	99	7.7	\$ 536	\$ 561
	48"W x 24"D	61248C	88	5.7	\$ 490	\$ 513
 Conference End 29½"H 42" Diameter w/30"D side 36" Diameter w/24"D side		61429D	78	8.2	\$ 559	\$ 585
		61369D	65	7.1	\$ 518	\$ 542
 Conference End w/casters 29½"H 42" Diameter w/30"D side 36" Diameter w/24"D side		61429DC	78	8.2	\$ 599	\$ 627
		61369DC	65	7.1	\$ 558	\$ 584





E A Easy to assemble.

SPECIFY: Model.Laminate/Paint/T-mold
Model/Paint Grade "2".Laminate/Paint/T-Mold



EXAMPLES: 61372.NSS
613722.ST1S

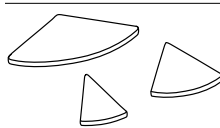
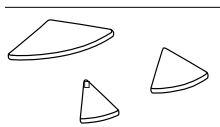
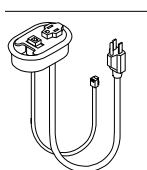
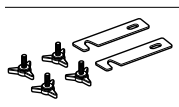

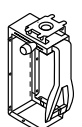
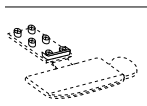
► **NEW!** Paint grade options.

	Description	Model	Ship Weight	Cube	List by Paint Grade	
					Core	Metallics "2"
	Teardrop Table 29½"H 42" Diameter with two 30"D sides	61423T	78	8.2	\$ 624	\$ 653
	36" Diameter with two 24"D sides	61303T	65	7.1	\$ 583	\$ 610
E A						
	Teardrop Table w/casters 29½"H 42" Diameter with two 30"D sides	61423TC	78	8.2	\$ 663	\$ 694
	36" Diameter with two 24"D sides	61303TC	65	7.1	\$ 624	\$ 653
E A						
	30"D x 30"D x 42" 90 Degree Connector	61190	31	2.3	\$ 216	
	30"D x 30"D x 23" 45 Degree Connector	61145	30	2.3	\$ 182	
	30"D x 30"D x 15" 30 Degree Connector	61130	29	2.3	\$ 172	
	NOTE: Includes 2 attachment brackets and 8 thumb screws in Black only.					
	24"D x 24"D x 33" 90 Degree Connector	61090	30	2.3	\$ 197	
	24"D x 24"D x 18⅞" 45 Degree Connector	61045	29	2.3	\$ 167	
	24"D x 24"D x 13" 30 Degree Connector	61030	28	2.3	\$ 158	
	NOTE: Includes 2 attachment brackets and 8 thumb screws in Black only.					
	Data and Electrical Receptacle — 6 Pin RJ11	H61011E6	2.0	0.2	\$ 89	
	— 8 Pin RJ45	H61011E8	2.0	0.2	\$ 89	
	Specify: Grommet Color					
	NOTE: Fits into worksurface grommets; provides one 15-amp simplex receptacle and one data port. Includes 6' long voice/data cable and 6' long power cord. Receptacles CANNOT be linked together. SPECIFY: Black (P), Carob (T8), Charcoal (S), Greige (T5), Light Gray (Q), Muslin (T3), Putty (L), Tan (V) D D , Taupe (E), Platinum Metallic (T1).					
						GSA — Above models receive Initiate Panel System discounting.
	Easy Connector Kit	60999	0.5	0.1	\$ 37	
	For quick connection of rectangular-shaped desks to rectangular-shaped desks. NOTE: Includes 4 knobs and 2 hooks.					
Black only						
	Laminate keyboard dimensions, 21½"W x 10¼"D	DLKP	10	0.7	\$ 193	
	<ul style="list-style-type: none"> • Minimum clearance for mounting: 20"W x 15½"D. • Fits all Education Workstations and 61000 Series Tables. • Black only, (P) laminate specification color code required. • Must use Adapter Kit EDKBRDAC when mounting to 72"W 61000 Series Tables. • Clearance for keyboards up to 2.75" in height. 					
Black only						
	CPU Holder	CPU2	7.5	0.5	\$ 132	
	<ul style="list-style-type: none"> ► Black Finish • Supports up to 85 lbs. • Height adjustable from 15" to 24" below worksurface. • Width adjustable to accept units from 3" to 9"W. • Must use Adapter Kit EDKBRDAC when mounting to 72"W 61000 Series Tables. 					
Black only						GSA — Above model receives Initiate Panel System discounting.
SIN 711-1, 711-2						
	Keyboard Adapter Kit for 72"W Workstation	EDKBRDAC	2	0.2	\$ 32	
	NOTES: Consists of mounting blocks and decorative end cap to maintain aesthetics. Order DLKP keyboards separately. For use with 72" and 84"W Education Workstation and 72"W 61000 Series Tables. Allows attachment of DLKP, CPU2 and CPU3.					

**SPECIFY: Model.Laminate/Paint/T-mold
Model/Paint Grade "2": Laminate/Paint/T-Mold**

 **Easy to assemble.**
 **Discontinued 12/26/2009.**
 **Shippable by small-package carrier.**

**EXAMPLES: 61423T.NSS
61423T2.ST1S**

Components used are listed on pages 432-433. Order components individually.
Other configurations are possible, including various sizes of some components.

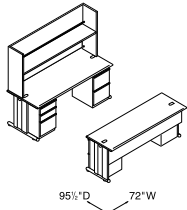

Desk Workstation
72"W x 95½"D

Qty.	Model #	Description	List Price	Price Extension
1	66591	Desk 72"W x 29½"D x 29½"H	\$ 703	\$ 703
1	23823	Mobile Pedestal – file/file 26⅞"H x 22⅞"D x 15"W	\$ 432	\$ 432
1	T72	Tackboard for 72"W Stack-on	\$ 310	\$ 310
1	16720R	Mobile Pedestal – box/box/file 26⅞"H x 19⅞"D x 15"W	\$ 473	\$ 473
1	16723R	Mobile Pedestal – box/box/file 26⅞"H x 22⅞"D x 15"W	\$ 491	\$ 491
1	66597	Desk 72"W x 24"D x 29½"H	\$ 680	\$ 680
1	38224N	Stack-on Open Shelf 72"W x 13½"D x 36¼"H	\$ 489	\$ 489
1	16820R	Mobile Pedestal – file/file 26⅞"H x 19⅞"D x 15"W	\$ 473	\$ 473
TOTAL:			\$ 4,051	

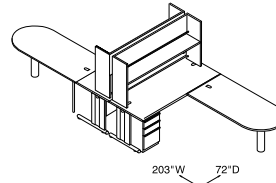

Desk with Peninsula Workstation
72"W x 203"D

Qty.	Model #	Description	List Price	Price Extension
2	66591	Desk 72"W x 29½"D x 29½"H	\$ 703	\$ 1,406
2	H831130	Peninsula Attachment Bracket	\$ 38	\$ 76
2	830098	Support Column for Peninsula 29½"H	\$ 166	\$ 332
2	38224N	Stack-on Open Shelf 72"W x 13½"D x 36¼"H	\$ 489	\$ 978
2	66472	Peninsula 72"W x 32¼"D x 29½"H	\$ 553	\$ 1,106
2	51001	1-Pack Leg for Peninsula Support 29½"H	\$ 51	\$ 102
2	16723R	Mobile Pedestal – box/box/file 26⅞"H x 22⅞"D x 15"W	\$ 491	\$ 982
TOTAL:			\$ 4,982	

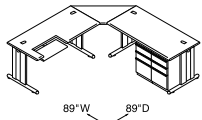

Desk "L" Workstation
89"W x 89"D

Qty.	Model #	Description	List Price	Price Extension
1	66571	Desk 60"W x 29½"D x 29½"H	\$ 663	\$ 663
1	608524	90° 2-way Connector Top 5½" x 29½" x 48" x 29½"	\$ 380	\$ 380
2	16723R	Mobile Pedestal – box/box/file 26⅞"H x 22⅞"D x 15"W	\$ 491	\$ 982
1	66361R	Desk with Adjustable Left Keyboard 60"W x 29½"D x 29½"H	\$ 879	\$ 879
TOTAL:			\$ 2,904	

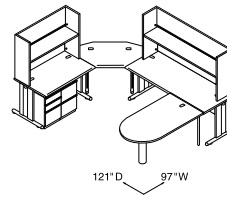

Peninsula "U" with Corner Workstation – Left
97"W x 121"D

Qty.	Model #	Description	List Price	Price Extension
1	16723R	Mobile Pedestal – box/box/file 26⅞"H x 22⅞"D x 15"W	\$ 491	\$ 491
1	66460	Peninsula 60"W x 32¼"D x 29½"H	\$ 537	\$ 537
1	830098	Support Column for Peninsula 29½"H	\$ 166	\$ 166
1	T72	Tackboard for 72"W Stack-on	\$ 310	\$ 310
1	H831130	Peninsula Attachment Bracket	\$ 38	\$ 38
1	51001	1-Pack Leg for Peninsula Support 29½"H	\$ 51	\$ 51
1	66551	Desk 48"W x 29½"D x 29½"H	\$ 618	\$ 618
1	T48	Tackboard for 48"W Stack-on	\$ 257	\$ 257
1	38224N	Stack-on Open Shelf 72"W x 13½"D x 36¼"H	\$ 489	\$ 489
1	16823R	Mobile Pedestal – file/file 26⅞"H x 22⅞"D x 15"W	\$ 491	\$ 491
1	66282	Corner Desk 29½"H with 24" sides	\$ 895	\$ 895
1	66591	Desk 72"W x 29½"D x 29½"H	\$ 703	\$ 703
1	38221N	Stack-on Open Shelf 48"W x 13½"D x 36¼"H	\$ 405	\$ 405
TOTAL:			\$ 5,451	

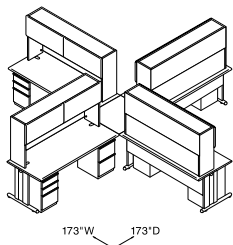

Quad Desk Workstation
173"W x 173"D

Qty.	Model #	Description	List Price	Price Extension
4	66591	Desk 72"W x 29½"D x 29½"H	\$ 703	\$ 2,812
1	608625	4-way Connector Top 29" x 29" x 29" x 29"	\$ 300	\$ 300
4	T72	Tackboard for 72"W Stack-on	\$ 310	\$ 1,240
4	16723R	Mobile Pedestal – box/box/file 26⅞"H x 22⅞"D x 15"W	\$ 491	\$ 1,964
4	38244N	Stack-on 72"W x 13½"D x 36¼"H	\$ 616	\$ 2,464
4	16823R	Mobile Pedestal – file/file 26⅞"H x 22⅞"D x 15"W	\$ 491	\$ 1,964
4	38249	Flipper Doors 2@36"W x 16"H	\$ 344	\$ 1,376
TOTAL:			\$12,120	

index accessories education tables storage & files seating systems desking

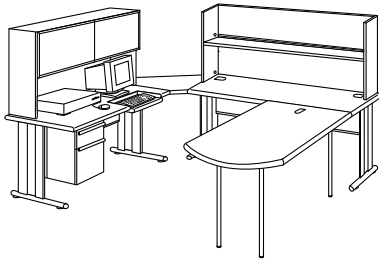

Peninsula Applications (NOT TO BE USED FREESTANDING)

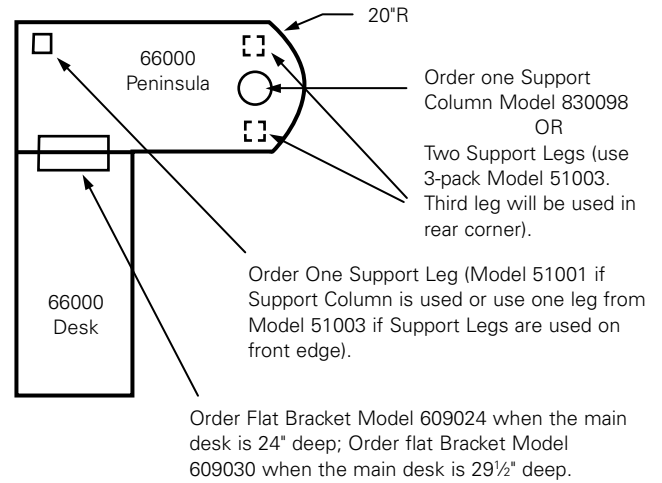
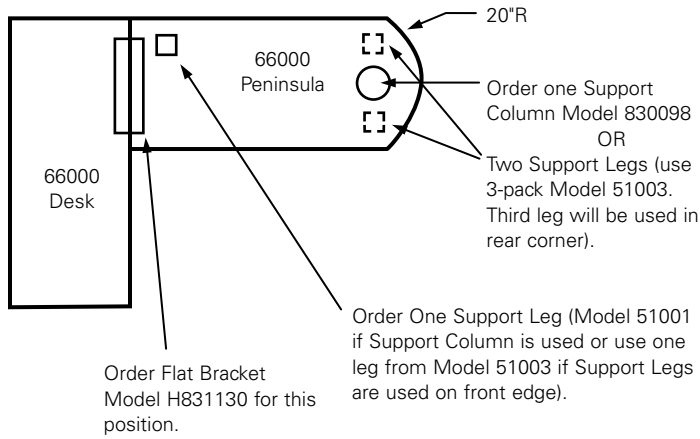

PENINSULA WORKSURFACES CAN ONLY FUNCTION WITH 29½"H PRIMARY UNITS. VARIABLE HEIGHT APPLICATIONS ARE NOT PROVIDED.

Connector Top Applications

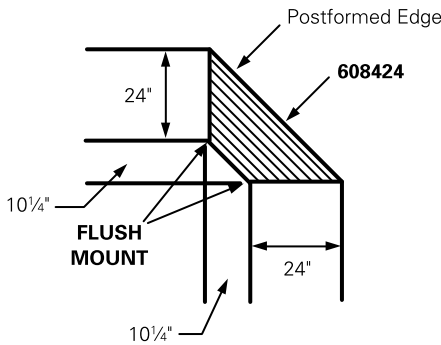

ALL CONNECTOR TOPS INCLUDE NECESSARY HARDWARE.

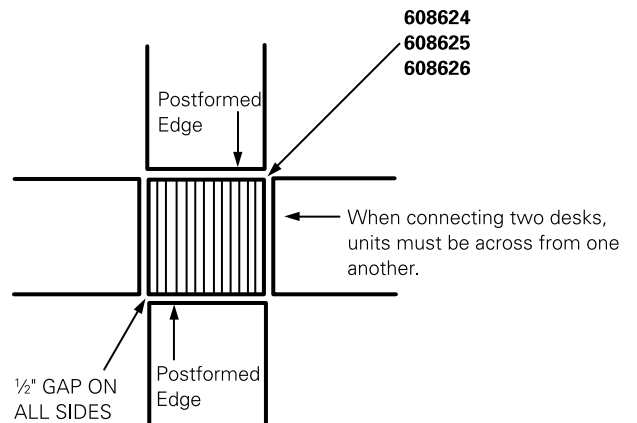
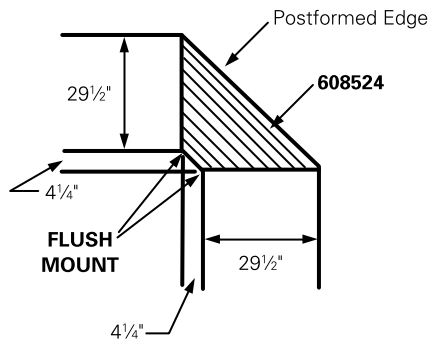
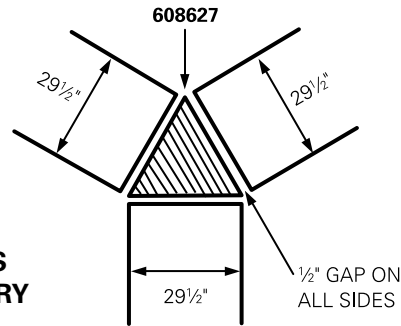

Connector Tops can be offset from main surfaces by using Step Brackets.

NOTE: Lines represent grain direction.

66000 Series/The StationMaster®

GSA SIN 711-2

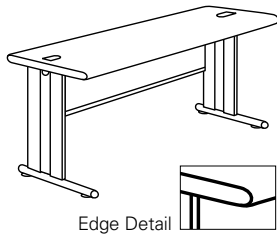

- ▶ **NEW!** Paint grade options.
- ▶ Tops are 1½" thick, post-formed front and back with ⅝" full radius. Ends are self-edged.
- ▶ Specify laminate and paint.
- ▶ Two leveling glides per leg with ¼" adjustability.
- ▶ High-pressure laminate tops have low-glare surfaces, radius edges, and black grommets for wire management.
- ▶ Wire management in C-legs is concealed on 24"D and 30"D desks.
- ▶ Meets or exceeds ANSI/BIFMA and ISTA performance standards.

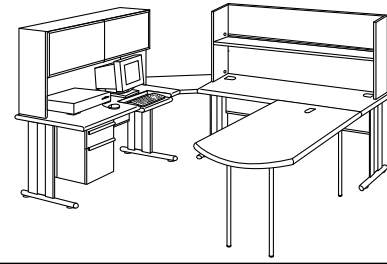

List by Paint Grade

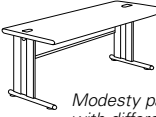
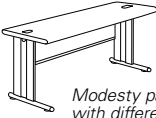
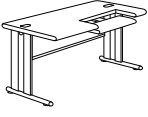
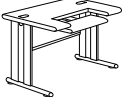
Description	Top Size	Model	Ship Weight	Cube	Core	Metallics "2"
 <p>Desk 29½"H <i>Modesty panel shown with different lengths.</i></p>	72"W x 29½"D	66591	129	11.0	\$ 703	\$ 768
	66"W x 29½"D	66581	122	10.1	\$ 684	\$ 749
	60"W x 29½"D	66571	113	9.2	\$ 663	\$ 728
	48"W x 29½"D	66551	95	7.5	\$ 618	\$ 683
	42"W x 29½"D	66531	88	6.6	\$ 592	\$ 657
	36"W x 29½"D	66541	76	5.7	\$ 568	\$ 633
 <p>Desk 29½"H <i>Modesty panel shown with different lengths.</i></p>	72"W x 24"D	66597	116	9.1	\$ 680	\$ 745
	66"W x 24"D	66582	111	8.1	\$ 663	\$ 728
	60"W x 24"D	66577	99	7.7	\$ 632	\$ 697
	48"W x 24"D	66557	88	5.7	\$ 588	\$ 653
	42"W x 24"D	66537	82	5.6	\$ 561	\$ 626
	36"W x 24"D	66547	77	4.3	\$ 537	\$ 602
 <p>Desk with Adjustable Right Keyboard, 29½"H x 60"W x 29½"D 29½"H x 48"W x 29½"D Desk with Adjustable Left Keyboard, 29½"H x 60"W x 29½"D NOTE: Keyboard Platform: 10½"D x 23¼"W; 6" vertical adjustment; 25° tilt</p>		66362L	117	9.8	\$ 879	\$ 944
		66352L	101	8.1	\$ 807	\$ 872
		66361R	117	9.8	\$ 879	\$ 944
 <p>Desk with Adjustable Keyboard, 29½"H x 36"W x 29½"D NOTE: Keyboard Platform: 10½"D x 23¼"W — centered; 6" vertical adjustment; 25° tilt</p>		66341	86	9.2	\$ 741	\$ 806

NOTE: Additional accessories and design information on pages 149-150, 431 and 433.

Easy to assemble.

**SPECIFY: Model.Laminate/Paint
Model/Paint Grade "2". Laminate/Paint**

**EXAMPLES: 66591.NS
665912.S.T1**











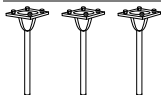

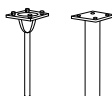

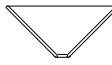







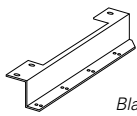



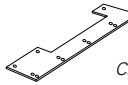



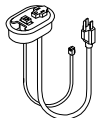

▶ **NEW!** Paint grade options. ▶ See page 431 for 66000 Series design information.
▶ Use peninsula tops in "L" or "U" configurations only. They are not intended for stand-alone applications.

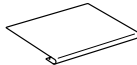

▶ For peninsula top support, order one each 830098 column and one each Model 51001 support leg or one 3-pack of legs, Model 51003.
▶ Connector tops are available to connect desks in multiple configurations.

▶ Tops are 1 1/8" thick.
▶ Optional dual-wheel casters are available for use on 66000 Series Furniture.
▶ Pull-up receptacle fits in all grommets.

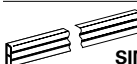
▶ Drawers and keyboard platforms shown on pages 465-468.
▶ 29 1/2"D Rectangular tables will accept the HKB800 Keyboard Platform.

▶ 24"D Rectangular tables will accept the HKB200, HKB700, HKB900 and 840000 Keyboard Platforms.

Description	Top Size	Model	Ship Weight	Cube	List by Paint Grade	
					Core	Metallics "2"
 Peninsula 29 1/2"H Order Bracket Model 609024 for connection to 24"D 66000 desks (attachment at the end – Left or Right). Order Bracket Model 609030 for connection to 29 1/2"D 66000 desks (attachment at the end – Left or Right). Order Bracket Model H831130 for connection to 66000 Series desks where peninsula is in the "Return" position. Specify: laminate and paint.	72"W x 32 1/4"D	66472	108	6.5	\$ 553	\$ 578
	60"W x 32 1/4"D	66460	92	5.8	\$ 537	\$ 562
 3-Pack Legs for Peninsula Support Color: black See page 431 for additional information.	29 1/2"H	51003	10 	2.9	\$ 118	
 1-Pack Leg for Peninsula Support Color: Black Support Column — 3" diameter NOTE: If a support column is used, one each Model 51001 must also be ordered. See page 431 for additional information.	29 1/2"H	51001	4 	1.4	\$ 51	
	830098	12 	1.1	\$ 166		
 90° 2-Way Connector Top NOTE: Includes attachment brackets.	14" x 24" x 48" x 24"	608424	34 	2.6	\$ 348	
	5 1/2" x 29 1/2" x 48" x 29 1/2"	608524	37 	3.2	\$ 380	
 3-Way Connector Top NOTE: Includes attachment brackets.	29" x 29" x 29"	608627	28 	2.6	\$ 348	
 4-Way Connector Top NOTE: Includes attachment brackets. When connecting two units, surfaces must be opposite each other, not at 90°.	24" x 24" x 24" x 24"	608624	37 	1.8	\$ 269	
	29" x 29" x 29" x 29"	608625	51 	2.6	\$ 300	
	29 1/2" x 24" x 29 1/2" x 24"	608626	43 	1.7	\$ 269	
 Step Bracket for 24"D Tops 3" offset, connects Right Side of Desk 3" offset, connects Left Side of Desk Step Bracket for 29 1/2"D Tops 3" offset, connects Right Side of Desk 3" offset, connects Left Side of Desk Black only		609384R	4 	0.9	\$ 50	
		609383L	5 	0.9	\$ 50	
		609388R	5 	0.9	\$ 50	
		609387L	5 	0.9	\$ 50	
 Flat Bracket for Peninsula attachment at end of 24"D desk Flat Bracket for Peninsula attachment at end of 29 1/2"D desk Flat Bracket for Peninsula attachment perpendicular to 29 1/2"D desk at "Return" position Charcoal only		609024	5 	0.9	\$ 39	
		609030	5 	0.9	\$ 39	
		H831130	3 	0.4	\$ 38	
 SIN 711-1, 711-2 Pull-up Receptacle NOTE: Fits into worksurface grommets; provides three 10-amp simplex receptacles with circuit breaker and 6' cord with plug. May interfere with storage modules. Black only		H870300	2.0 	0.2	\$ 162	
 SIN 711-1, 711-2 Data and Electrical Receptacle Specify: Grommet Color NOTE: Fits into worksurface grommets; provides one 15-amp simplex receptacle and one data port. Includes 6' long voice/data cable and 6' long power cord. Receptacles CANNOT be linked together. SPECIFY: Black (P), Carob (T8), Charcoal (S), Greige (T5), Light Gray (Q), Muslin (T3), Putty (L), Tan (V)   , Taupe (E), Platinum Metallic (T1). GSA — Above models receive Initiate Panel System.	- 6 Pin RJ11	H61011E6	2.0 	0.2	\$ 89	
	- 8 Pin RJ45	H61011E8	2.0 	0.2	\$ 89	
 Dual-Wheel Casters (4/Pack) NOTE: Use of casters will increase overall height 2". Black only		62596	1 	0.6	\$ 44	
 Corner Sleeve for 66000 Series (Full Bull Nose) NOTE: Specify paint. SIN 711-1, 711-2, 711-11 GSA — Above model receives Simplicity II Panel System.		51205	10 	1.5	\$ 89	\$ 96
 Wire Manager (92"L) NOTE: Self-adhesive backing attaches to underside of worksurfaces. Black only SIN 711-1 GSA — Above model receives Simplicity II Panel System discounting.		HEV920	10 	.5	\$ 87	

  Discontinued 12/26/2009.
 Shippable by small-package carrier.

SPECIFY: AS NOTED

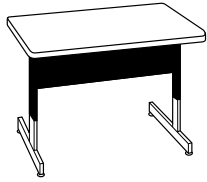

- ▶ 1½" thick top with T-mold.
- ▶ Minimum 45 lbs. industrial grade substrate.
- ▶ Surface: scratch-resistant melamine impregnated laminate.
- ▶ 1" Radius corners.
- ▶ See typical below for layout options.

- ▶ Hi-solids paint on upper legs and modesty panel.
- ▶ Adjustable non-marring leveling floor glides used where applicable.
- ▶ Metal modesty panel painted to match upper legs.
- ▶ Two section welded metal legs.

- ▶ Two screw locking system for adjustable legs.
- ▶ Adjustable from 22½" to 32½" H in 1" increments.
- ▶ Will not accept hanging pedestals or metal drawer.
- ▶ Wheel chair compatible.
- ▶ Meets or exceeds ANSI/BIFMA and ISTA performance standards.



	Description	Overhang	Model	Ship Weight	Cube	List
Adjustable Computer Desk with Modesty Panel	Rectangle Tops					
	60"W x 30"D x 22½" – 32½"H	12"	AM3060	95	6.8	\$ 428
	48"W x 30"D x 22½" – 32½"H	12"	AM3048	80	5.6	\$ 412
	36"W x 30"D x 22½" – 32½"H	12"	AM3036	67	4.4	\$ 400
	60"W x 24"D x 22½" – 32½"H	9"	AM2460R	75	5.7	\$ 413
	48"W x 24"D x 22½" – 32½"H	9"	AM2448R	66	4.6	\$ 391
	36"W x 24"D x 22½" – 32½"H	9"	AM2436R	57	3.6	\$ 363

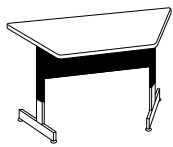

Trapezoid
60"W x 30"D x 22½" – 32½"H
48"W x 24"D x 22½" – 32½"H

12"
9"

AM3060TR
AM2448TR

74
46

6.8
4.6

\$ 503
\$ 438



Half-Round
60"W x 30"D x 22½" – 32½"H
48"W x 24"D x 22½" – 32½"H

12"
9"

AM3060HR
AM2448HR

80
51

6.8
4.6

\$ 509
\$ 443

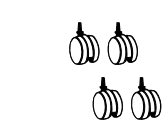

Caster Kit

CAST/T2

1

0.1

\$ 63

NOTES: Will increase height 2". 2 locking; 2 non-locking.

Black only

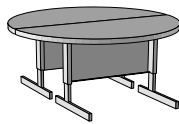

48"D 48"W

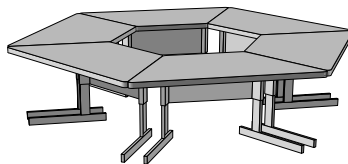

119"W 119"D

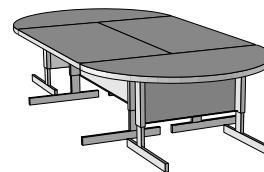

108"W 48"D

Wheel-chair compatible.

Easy to assemble.

Shippable by small-package carrier.

SPECIFY: Model number.Laminate.T-mold.Paint

EXAMPLE: AM3036.N.PP

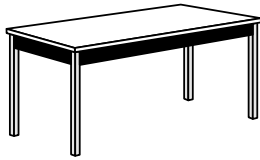

- ▶ 1½" thick top with self-edge.
- ▶ Adjustable non-marring leveling floor glides.
- ▶ Small radius corners.
- ▶ 1¼" square chrome or Black painted legs ONLY.
- ▶ Legs secured to top with steel corner brace.
- ▶ Meets or exceeds ANSI/BIFMA and ISTA performance standards.

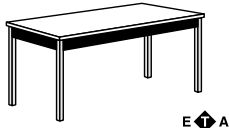

Description	Model	Ship Weight	Cube	List
Rectangle Shaped Utility Table – Metal				
72"L x 18"W x 29"H	UTM1872	73	4.8	\$ 334
40"L x 20"W x 29"H	UTM2040	50	3.3	\$ 267
60"L x 20"W x 29"H	UTM2060	68	4.9	\$ 300
60"L x 24"W x 29"H	UTM2460	81	5.6	\$ 320
60"L x 30"W x 29"H	UTM3060	88	6.5	\$ 328
72"L x 30"W x 29"H	UTM3072	106	7.2	\$ 410
72"L x 36"W x 29"H	UTM3672	116	10.4	\$ 436

Table Finish Selection

Woodgrain Laminate: Henna Cherry (J), Mahogany (N), Medium Oak (M) or Natural Maple (D).

Solid Laminate: Light Gray (Q).

Patterned Laminate: Graphite (G3) or Gray (G2).

Paints: Black (P), Charcoal (S), Light Gray (Q) or Putty (L).

Leg Finish Selection

Chrome (CHR) or Black (P)

See page 1.
 Easy to assemble.
 Shippable by small-package carrier.

SPECIFY: Model.Laminate/Paint Color.Leg Paint (P) or Finish (CHR)

EXAMPLE: UTM1872.W.PCHR