

LATERAL FILES

Advantages:

a) The most efficient means of conventional filing; b) Ideal for active filing in workstations, where higher volume capacity is necessary and retrieval is frequent

Considerations:

2-drawer steel lateral files fit under standard-height worksurfaces when using panel systems.

BOOKCASES

Advantages:

a) These units are ideal for binders, reference books or other items; b) Available with your choice of fixed or movable shelves

Considerations:

If working with panel systems, it is more attractive to specify units that are lower than the panel height.

VERTICAL FILES

Advantages:

a) Economical; b) The most widely used filing method; c) requires minimal floorspace

Considerations:

Vertical files are best suited for long-term storage, where retrieval is less frequent. For larger banks of files, lateral files are more space-efficient than vertical files.

SHELF FILES

Advantages:

a) The highest density method of filing; b) Specially designed for end-tab long term filing

Considerations:

Ideal for medical or dental offices, available as open shelves or with flipper doors.

FILING TECHNIQUES

Type	Standing Files	Hanging Files	End-tab Files
Advantages	Inexpensive. Uses existing file folders.	Easier organization and identification of the file folders. Files viewed from top. Remaining files hold their place when folders are removed. Easier to re-stock.	Easiest and fastest file identification. Files viewed from side. Preferred solution for healthcare, insurance and other critical files with frequent retrieval. Easiest to re-stock.
Requirements	Follower block or Dividers	Hangrails or high-drawer sides	Front-access shelves
Can be used in	<ul style="list-style-type: none"> Vertical files (front-to-back only) Lateral files (side-to-side only in drawers or roll-out shelves) Shelf files (side-to-side only) 	<ul style="list-style-type: none"> Vertical files (front-to-back only) Lateral files (front-to-back or side-to-side in drawers or roll-out shelves) 	<ul style="list-style-type: none"> Lateral files (side-to-side only in roll-out shelves or fixed shelves) Shelf files (side-to-side only — ideal for high-density)

LATERAL FILING OPTIONS

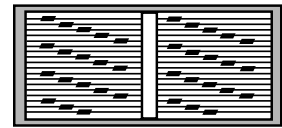

Front-to-back filing:

30" wide files*: 30½" of filing with letter/letter rows.

36" wide files*: 30½" of filing with letter/letter, legal/legal, or letter/legal rows.

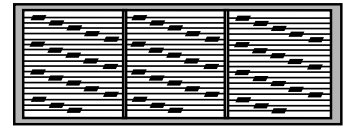

42" wide files:** 45¾" of filing with 3 rows letter or 30½" of 2 rows legal, or 2 standard printout rows.

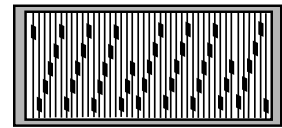

Side-to-side filing:

30" wide files: 27" of filing with letter or legal.

36" wide files: 33" of filing with letter or legal.

42" wide files: 39" of filing with letter or legal.

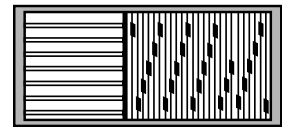

Combination filing:

(front-to-back with side-to-side in one drawer)

30" wide files: not recommended.
36" wide files: 15¼" of front-to-back filing and 20¼" of side-to-side legal filing.

42" wide files: 15¼" of front-to-back filing and 26¼" of side-to-side legal filing.

* Requires 919491 optional hangrails.
** Requires 919492 optional hangrails.

CONFIGURATION OPTIONS — LATERAL FILES

SERIES/ SUFFIX:	400L	500L	Flagship	600L, 700L, and 800L																			
Heights Offered:	2, 4	2, 4, 5	2, 3, 4, 5	2, 3, 4, 5																			
	<table border="1"> <tr><td>A</td></tr> <tr><td>A</td></tr> <tr><td>A</td></tr> <tr><td>A</td></tr> </table>	A	A	A	A	<table border="1"> <tr><td>B</td></tr> <tr><td>A</td></tr> <tr><td>A</td></tr> <tr><td>A</td></tr> <tr><td>A</td></tr> </table>	B	A	A	A	A	<table border="1"> <tr><td>B</td></tr> <tr><td>A</td></tr> <tr><td>A</td></tr> <tr><td>A</td></tr> <tr><td>A</td></tr> </table>	B	A	A	A	A	<table border="1"> <tr><td>B</td></tr> <tr><td>AB</td></tr> <tr><td>AB</td></tr> <tr><td>AB</td></tr> <tr><td>A</td></tr> </table>	B	AB	AB	AB	A
A																							
A																							
A																							
A																							
B																							
A																							
A																							
A																							
A																							
B																							
A																							
A																							
A																							
A																							
B																							
AB																							
AB																							
AB																							
A																							
Widths Offered:	30"	30", 36"	30", 36", 42"	30", 36", 42"																			
A. Standard drawers	B. Receding door with roll-out shelf		Posting shelf																				
Most popular. Holds: <ul style="list-style-type: none"> Standing files Hanging files Letter, legal or A4 Supplies Side-to-side standard, Front-to-back optional	More flexible. Holds: <ul style="list-style-type: none"> End-tab files Standing files Hanging files Letter, legal or A4 Larger/boxed supplies Side-to-side standard, Front-to-back optional		Convenient for access, review and replacement of records; only available on select 5-high models.																				

NOTE: AB designated drawers are available either as all "A" or all "B" within a cabinet.

Storage and Files Ordering Information

For all paint options — see page 337.



		Flagship® Product [Ⓢ]	Flagship® Desk Tower Worksurfaces [Ⓢ]	Brigade Pedestals [Ⓢ]	Embark Pedestals [Ⓢ]	Optional Laminate Tops for Pedestals [Ⓢ]	800, 700, 600 Lateral Files [Ⓢ]	500, 400 Lateral Files [Ⓢ]	Overfiles [Ⓢ]	Optional Laminate Tops for Lateral Files [Ⓢ]	210/250B Series Vertical Files [Ⓢ]	310/H320 Series Vertical Files [Ⓢ]	510/530 Series Vertical Files [Ⓢ]	Storage Cabinets	ETA Storage Cabinets	600 Series Shelf Files [Ⓢ]	FlameSafe Files	Steel Bookcases [Ⓢ]	Optional Laminate Tops for Steel Bookcases [Ⓢ]	1870/1890 Series Bookcases
LAMINATES		CODES																		
CORE	Bourbon Cherry	H	•			•				•									•	
	Columbian Walnut	Z	•			•				•									•	
	Henna Cherry	J	•			•				•									•	•
	Mahogany	N	•			•				•									•	•
	Shaker Cherry	F	•			•				•									•	
WOOD GRAIN	Medium Oak	M				•				•									•	•
	Natural Maple	D	•			•				•									•	
SOLID	Charcoal	S				•				•									•	
	Light Gray	Q				•				•									•	
	Parchment	K2	•																	
	Whitestone	K4	•																	
PATTERNED	Canyon Zephyr NEW!	K9	•			•				•									•	
	Cloud Zephyr NEW!	K7	•			•				•									•	
	Desert Zephyr NEW!	K8	•			•				•									•	
	Morro Zephyr NEW!	L9	•			•				•									•	
	Shadow Zephyr NEW!	K1	•			•				•									•	
	Graphite	G3	•			•				•									•	
	Gray	G2	•			•				•									•	
	Grey Tigris	L6	•																	
	White	G1	•			•				•									•	
EDGEBAND		CODES																		
	Black	P	•																	
	Carob NEW!	G	•																	
	Charcoal	S	•																	
	Greige NEW!	R	•																	
	Light Gray	Q	•																	
	Muslin	T	•																	
	Platinum	K	•																	
	Putty	L	•																	
	Tan D D	V	•																	
	Taupe	E	•																	

NOTE: Arch pulls available in Satin Chrome only.
For all paint options — see page 337.

Ⓢ Core Product Line
D D Discontinued 12/26/2009.

		Flagship® Product ©	Flagship® Desk Tower Worksurfaces ©	Brigade Pedestals ©	Embark Pedestals ©	Optional Laminated Tops for Pedestals	800, 700, 600 Lateral Files ©	500, 400 Lateral Files ©	Overfiles ©	Optional Laminated Tops for Lateral Files ©	210/250B Series Vertical Files ©	310/H320 Series Vertical Files ©	510/530 Series Vertical Files ©	Storage Cabinets	ETA Storage Cabinets	600 Series Shelf Files ©	Flame Safe Files	Steel Bookcases ©	Optional Laminated Tops for Steel Bookcases ©	1870/1890 Series Bookcases
PAINTS		CODES																		
CORE	Black	P	•	•	•	•	•	•	•	•	•	•	•	•	•	•	•	•	•	•
	Carob <i>NEW!</i>	T8	•	•	•	•	•	•	•	•	•	•	•	•	•	•	•	•	•	•
	Charcoal	S	•	•	•	•	•	•	•	•	•	•	•	•	•	•	•	•	•	•
	Greige <i>NEW!</i>	T5	•	•	•	•	•	•	•	•	•	•	•	•	•	•	•	•	•	•
	Light Gray	Q	•	•	•	•	•	•	•	•	•	•	•	•	•	•	•	•	•	•
	Muslin	T3	•	•	•	•	•	•	•	•	•	•	•	•	•	•	•	•	•	•
	Putty	L	•	•	•	•	•	•	•	•	•	•	•	•	•	•	•	•	•	•
	Taupe	E	•	•	•	•	•	•	•	•	•	•	•	•	•	•	•	•	•	•
Tan D D	V	•	•	•	•	•	•	•	•	•	•	•	•	•	•	•	•	•	•	
CHOICE COLORS (GRADE 2)																				
CHOICE METALLICS	Champagne Metallic <i>NEW!</i>	T4	•	•	•	•	•	•	•	•	•	•	•	•	•	•	•	•	•	•
	Platinum Metallic <i>NEW!</i>	T1	•	•	•	•	•	•	•	•	•	•	•	•	•	•	•	•	•	•
Haworth	Beige	D1	•	•	•	•	•	•	•	•	•	•	•	•	•	•	•	•	•	•
	Chalk ¹	T3	•	•	•	•	•	•	•	•	•	•	•	•	•	•	•	•	•	•
	Charcoal	D2	•	•	•	•	•	•	•	•	•	•	•	•	•	•	•	•	•	•
	Graphite	D5	•	•	•	•	•	•	•	•	•	•	•	•	•	•	•	•	•	•
	Putty	D6	•	•	•	•	•	•	•	•	•	•	•	•	•	•	•	•	•	•
	Sand	D3	•	•	•	•	•	•	•	•	•	•	•	•	•	•	•	•	•	•
	Smoke	D7	•	•	•	•	•	•	•	•	•	•	•	•	•	•	•	•	•	•
	Stone	D4	•	•	•	•	•	•	•	•	•	•	•	•	•	•	•	•	•	•
Herman Miller	Black Umber	J4	•	•	•	•	•	•	•	•	•	•	•	•	•	•	•	•	•	•
	Dark Tone	J1	•	•	•	•	•	•	•	•	•	•	•	•	•	•	•	•	•	•
	Inner Tone	J2	•	•	•	•	•	•	•	•	•	•	•	•	•	•	•	•	•	•
	Inner Tone Light	J5	•	•	•	•	•	•	•	•	•	•	•	•	•	•	•	•	•	•
	Just Tan	J7	•	•	•	•	•	•	•	•	•	•	•	•	•	•	•	•	•	•
	Light Gray	J3	•	•	•	•	•	•	•	•	•	•	•	•	•	•	•	•	•	•
	Light Tone	J6	•	•	•	•	•	•	•	•	•	•	•	•	•	•	•	•	•	•
	Medium Tone	H8	•	•	•	•	•	•	•	•	•	•	•	•	•	•	•	•	•	•
Slate Gray	H7	•	•	•	•	•	•	•	•	•	•	•	•	•	•	•	•	•	•	
Knoll	Dark Gray	J8	•	•	•	•	•	•	•	•	•	•	•	•	•	•	•	•	•	•
	Jet Black ²	P	•	•	•	•	•	•	•	•	•	•	•	•	•	•	•	•	•	•
	Light Gray	J9	•	•	•	•	•	•	•	•	•	•	•	•	•	•	•	•	•	•
	Medium Gray	K1	•	•	•	•	•	•	•	•	•	•	•	•	•	•	•	•	•	•
	Pewter	K2	•	•	•	•	•	•	•	•	•	•	•	•	•	•	•	•	•	•
	Pumice	K4	•	•	•	•	•	•	•	•	•	•	•	•	•	•	•	•	•	•
	Soft Gray	K3	•	•	•	•	•	•	•	•	•	•	•	•	•	•	•	•	•	•
Taupe	K5	•	•	•	•	•	•	•	•	•	•	•	•	•	•	•	•	•	•	
Steelcase	Black ³	P	•	•	•	•	•	•	•	•	•	•	•	•	•	•	•	•	•	•
	Cream	K6	•	•	•	•	•	•	•	•	•	•	•	•	•	•	•	•	•	•
	Grey Value 1	K9	•	•	•	•	•	•	•	•	•	•	•	•	•	•	•	•	•	•
	Midnight	K7	•	•	•	•	•	•	•	•	•	•	•	•	•	•	•	•	•	•
	Smoke	H5	•	•	•	•	•	•	•	•	•	•	•	•	•	•	•	•	•	•
	Tan Value 1	K8	•	•	•	•	•	•	•	•	•	•	•	•	•	•	•	•	•	•
Warm Brown Value 2	H6	•	•	•	•	•	•	•	•	•	•	•	•	•	•	•	•	•	•	

Choice/Metallics are paint grade 2, and do not require a customer approval. Add a "2" at the end of the model number to designate Choice/Metallics Grade 2.

For Champagne Metallic Paint, Greige is the suggested edgeband color. When Champagne Metallic Paint is selected, pulls are standard in Greige.

¹ Haworth Chalk is the same as HON Muslin. When ordering this color use the HON Muslin paint code T3.

² Knoll Jet Black is the same as HON Black. When ordering this color use the HON Black paint code P.

³ Steelcase Black is the same as HON Black. When ordering this color use the HON Black paint code P.

NOTES: Choice color selections do not require a customer approval. The colors can be ordered with the HON paint code noted above. If unsure of the color, please request a metal sample from HON Literature Fulfillment. When specifying a Choice color the number 2 must be placed at the end of the model number then a period. After the period the HON paint code should be entered.

Pricing for eligible product is listed on the individual list pricer pages under the column Choice/Metallic column.

No minimum order is required.

Refer to page 9 for detailed information on the Color Correct™ Program.

© Core Product Line

Custom Paint Colors

Custom Paint Colors require a specials number which can be obtained by calling HON Customer Service at 1-800-833-3964 option 2. When ordering, designate with a "3" at the end of the model number.

Flagship® Personal Storage Tower

GSA SIN 711-3

HON
Smart now. Smarter later.

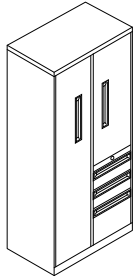

- ▶ **NEW!** Choice/Metallic and Custom paint options.
- ▶ See specifying information below for Choice/Metallic paint and pages 9 and 337 for Custom paint ordering instructions.
- ▶ Steel ball bearing suspension on box and file drawers.
- ▶ Each box drawer contains one divider, file drawers contain one follower block and one crossrail.
- ▶ One cam lock secures all doors/drawers.
- ▶ Equipped with HON "One Key" interchangeable core removable locks.
- ▶ Four adjustable leveling glides.
- ▶ See page 357 for pedestal accessories.
- ▶ Arch pull available in Satin Chrome only.
- ▶ Choose from any of four pull options with no upcharge.
- ▶ See the HON October New Product pricer for new 48½"H Flagship Personal Storage Towers.

- ▶ Omit lock-option available. See page 463 for ordering instructions.
- ▶ Choose paint/color grades. See pages 336 and 337 for paint options.
- ▶ Meets or exceeds ANSI/BIFMA and ISTA performance standards.



Suffix "A"



Arch Pull

Suffix "N"



Full Face Integral Drawer Pull

Suffix "K"



38000 Series Style Drawer Pull

Suffix "R"



Full Radius Drawer Pull

ONE KEY Refer to page 463

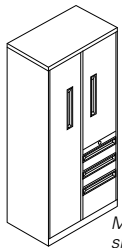

Model ST18730RK shown

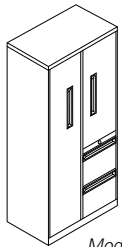

Model ST18830RK shown

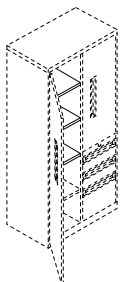

Description	Model	Ship Weight	Cube	List by Paint Grade		
				Core	Choice/Metallics "2"	Custom "3"
30"W x 18"D x 64¼"H Closet & 2 adjustable shelves, Box/Box/File, Right	ST18730R(?)	195	26.8	\$1904	\$1964	\$2024
30"W x 18"D x 64¼"H Closet & 2 adjustable shelves, Box/Box/File, Left NOTES: Wardrobe side measures 14¼"W x 18"D and includes non-adjustable shelf, coat rod and coat hook. Storage side includes two adjustable shelves which adjust in 2" increments and B/B/F drawers. One lock secures entire unit.	ST18730L(?)	195	26.8	\$1904	\$1964	\$2024
30"W x 18"D x 64¼"H Closet & 2 adjustable shelves, File/File, Right	ST18830R(?)	195	26.8	\$1904	\$1964	\$2024
30"W x 18"D x 64¼"H Closet & 2 adjustable shelves, File/File, Left NOTES: Wardrobe side measures 14¼"W x 18"D and includes non-adjustable shelf, coat rod and coat hook. Storage side includes two adjustable shelves which adjust in 2" increments and F/F drawers. One lock secures entire unit.	ST18830L(?)	195	26.8	\$1904	\$1964	\$2024
Fixed Shelf Accessory Pack (3/pack)	ST3SHLF	16.8	0.6	\$ 251	\$ 261	\$ 271

NOTES: Includes 3 fixed shelves and two skins to cover outer wall vertical uprights. Shelf locations are not adjustable. Shelves and skins are field installable by either the customer or installer.

Converts Flagship Tower wardrobe into 5 storage bays (with one fixed shelf from Tower). The middle three bays have 12" of clearance to accommodate binders. The top bay has 8½" of clearance and the bottom bay has 9¾" of clearance.

The Flagship Tower is standard with one fixed shelf.

GSA — Above models receive Other Filing & Storage discounting.

NOTE: See page 357 for Pedestal Accessories.

Discontinued 4/3/2009.

Omit lock core.

SPECIFY: Model (Pull).Paint
 Model (Pull)/Paint Grade "2".Paint
 Model (include omit lock X)(Pull).Paint
 Model (include omit lock X)(Pull)/Paint Grade "2".Paint

EXAMPLES: ST18730RA.P
 ST18730RA2.T1
 ST18730RXA.P
 S18730RXA2.T1

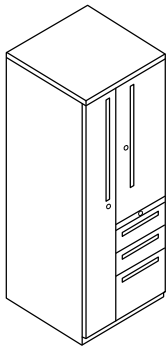

- ▶ **NEW!** Choice/Metallic and Custom paint options.
- ▶ See specifying information below for Choice/Metallic paint and pages 9 and 337 for Custom paint ordering instructions.
- ▶ Steel ball bearing suspension on box and file drawers.
- ▶ Each box drawer contains one divider, file drawers contain one follower block and one crossrail.
- ▶ 24"W x 24"D footprint allows use within Systems applications by matching 24"D worksurfaces.
- ▶ Equipped with HON "One Key" interchangeable core removable locks.
- ▶ Four adjustable leveling glides.
- ▶ See page 357 for pedestal accessories.
- ▶ Arch pull available in Satin Chrome only.
- ▶ Choose from any of three pull options with no upcharge.
- ▶ See the HON October New Product pricer for new 48½"H Flagship Personal Storage Towers.
- ▶ Omit lock-option available. See page 463 for ordering instructions.
- ▶ Choose paint/color grades. See pages 336 and 337 for paint options.
- ▶ Meets or exceeds ANSI/BIFMA and ISTA performance standards.

Suffix "A"



Arch Pull

Suffix "N"



Full Face Integral Drawer Pull

Suffix "R"



Full Radius Drawer Pull



ONE KEY Refer to page 463

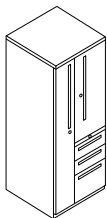

Model ST24723RN shown

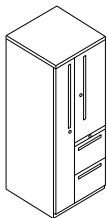

Model ST24823RN shown

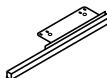

KP2424R

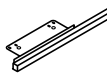

KP2424L

Description	Model	Ship Weight	Cube	List by Paint Grade		
				Choice/ Core	Custom "2"	Custom "3"
24"W x 24"D x 64¼"H Wardrobe and Storage with 2 adjustable shelves, Box/Box/File, Personal Storage Cabinet on Right	ST24723R(?)	233	26.6	\$1810	\$1870	\$1930
24"W x 24"D x 64¼"H Wardrobe and Storage with 2 adjustable shelves, Box/Box/File, Personal Storage Cabinet on Left NOTES: Wardrobe side measures 9"W x 24"D and includes a coat rod. Personal storage cabinet includes two adjustable shelves which adjust in 2" increments and B/B/F drawers. Wire management grommet in personal storage cabinet. Wardrobe, storage cabinet and pedestal all lock independently.	ST24723L(?)	233	26.6	\$1810	\$1870	\$1930
24"W x 24"D x 64¼"H Wardrobe and Storage with 2 adjustable shelves, File/File, Personal Storage Cabinet on Right	ST24823R(?)	229	26.6	\$1810	\$1870	\$1930
24"W x 24"D x 64¼"H Wardrobe and Storage with 2 adjustable shelves, File/File, Personal Storage Cabinet on Left NOTES: Wardrobe side measures 9"W x 24"D and includes a coat rod. Personal storage cabinet includes two adjustable shelves which adjust in 2" increments and F/F drawers. Wire management grommet in personal storage cabinet. Wardrobe, storage cabinet and pedestal all lock independently.	ST24823L(?)	229	26.6	\$1810	\$1870	\$1930
Flush Front Kick Plate for 24"W Towers NOTES: Mounts to base of tower to provide a flush appearance to coordinate with laterals and file centers. Kick plate is field-installable. Model KP2424R to be used on Personal Storage Tower with pedestal on right. Model KP2424L to be used on Personal Storage Tower with pedestal on left.	KP2424R KP2424L	2	0.1	\$ 99	\$ 104	\$ 109

GSA — Entire page receives Other Filing & Storage discounting.

NOTE: See page 357 for Pedestal Accessories.

- Omit lock core.
- Shippable by small-package carrier.

SPECIFY: Model (Pull).Paint
Model (Pull)/Paint Grade "2".Paint
Model (include omit lock X)(Pull).Paint
Model (include omit lock X)(Pull)/Paint Grade "2".Paint

EXAMPLES: ST24723RA.P
ST24723RA2.T1
ST24723RXA.P
S24730RXA2.T1

Flagship® Desk Tower

GSA SIN 711-3

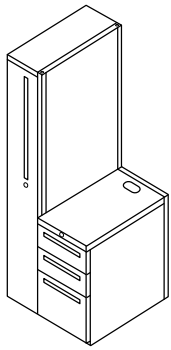

- ▶ **NEW!** Choice/Metallic and Custom paint options.
- ▶ See specifying information below for Choice/Metallic paint and pages 9 and 337 for Custom paint ordering instructions.
- ▶ Steel ball bearing suspension on box and file drawers.
- ▶ Each box drawer contains one divider, file drawers contain one follower block and one crossrail.
- ▶ 24"W x 24"D footprint allows use within systems applications by matching 24"D worksurfaces.
- ▶ Equipped with HON "One Key" interchangeable core removable locks.
- ▶ Four adjustable leveling glides.
- ▶ See page 357 for pedestal accessories.
- ▶ Arch pull available in Satin Chrome only.
- ▶ Choose from any of three pull options with no upcharge.
- ▶ See the HON October 2008 New Product pricer for new 48½"H Flagship Personal Storage Towers.
- ▶ Omit lock-option available. See page 463 for ordering instructions.
- ▶ Works with all 24"W Initiate Hang-on Accessories.
- ▶ Choose paint/color grades. See pages 336 and 337 for paint options.
- ▶ Meets or exceeds ANSI/BIFMA and ISTA performance standards.

Suffix "A"



Arch Pull

Suffix "N"

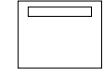

Full Face Integral Drawer Pull

Suffix "R"



Full Radius Drawer Pull



ONE KEY Refer to page 463

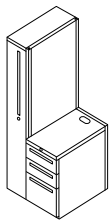

Model ST26723RN shown

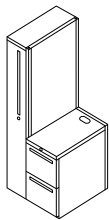

Model ST26823RN shown

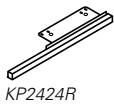

KP2424R

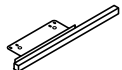

KP2424L

Description	Model	Ship Weight	Cube	List by Paint Grade		
				Choice/ Core	Custom "2"	Custom "3"
24"W x 24"D x 64¼"H Desk Tower, Box/Box/File pedestal on Right;	ST26723R(?)	170	26.6	\$1536	\$1596	\$1656
24"W x 24"D x 64¼"H Desk Tower, Box/Box/File pedestal on Left;	ST26723L(?)	170	26.6	\$1536	\$1596	\$1656
NOTES: Wardrobe side measures 9"W x 24"D and includes a coat rod. Wardrobe and pedestal lock independently.						
24"W x 24"D x 64¼"H Desk Tower, File/File pedestal on Right;	ST26823R(?)	167	26.6	\$1536	\$1596	\$1656
24"W x 24"D x 64¼"H Desk Tower, File/File pedestal on Left;	ST26823L(?)	167	26.6	\$1536	\$1596	\$1656
NOTES: Wardrobe side measures 9"W x 24"D and includes a coat rod. Wardrobe and pedestal lock independently.						
Flush Front Kick Plate for 24"W Towers	KP2424R	2	0.1	\$ 99	\$ 104	\$ 109
NOTES: Mounts to base of tower to provide a flush appearance to coordinate with laterals and file centers. Kick plate is field-installable. Model KP2424R to be used on Desk Tower with pedestal on right. Model KP2424L to be used on Desk Tower with pedestal on left.	KP2424L	2	0.1	\$ 99	\$ 104	\$ 109

GSA — Entire page receives Other Filing & Storage discounting.

NOTES: See pages 232-233 for 24"W Initiate Hang-on Accessories. See page 357 for Pedestal Accessories.



- Omit lock core.
- Shippable by small-package carrier.

SPECIFY: Model (Pull).Paint
 Model (Pull)/Paint Grade "2".Paint
 Model (include omit lock X)(Pull).Paint
 Model (include omit lock X)(Pull)/Paint Grade "2".Paint

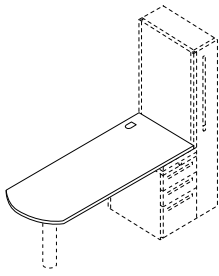
EXAMPLES: ST26723RA.P
 ST26723RA2.T1
 ST26723RXA.P
 S26723RXA2.T1

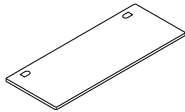

- ▶ Worksurfaces are high pressure laminate.
- ▶ Worksurfaces are 10" shorter than desired footprint to keep total dimension on panel.
- ▶ Worksurfaces available in flat, PVC edge.
- ▶ Grommet color and edge color match.
- ▶ Grommets standard on worksurfaces.
 - 2 grommets per rectangle
 - 1 grommet per peninsula and P-shaped
- ▶ P-shape towards seated side of surface.
- ▶ Peninsula and P-shaped worksurfaces are intended for freestanding applications and require support column NCNLEG29. See below.
- ▶ Choose paint/color grades. See pages 336 and 337 for paint options.
- ▶ Rectangle worksurfaces are to be used in panel hung applications only, using provided cantilever brackets.
- ▶ Meets or exceeds ANSI/BIFMA and ISTA standards.

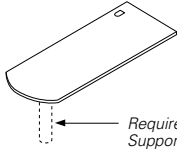
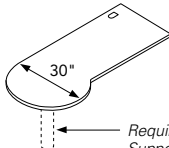
	Description	Model	Ship Weight	Cube	List
	Rectangle Worksurfaces				
	38"W x 24"D	SWR2438P	48 	2.9	\$ 355
	44"W x 24"D	SWR2444P	56 	3.2	\$ 375
	50"W x 24"D	SWR2450P	63	3.4	\$ 394
	56"W x 24"D	SWR2456P	71	4.1	\$ 438
	62"W x 24"D	SWR2462P	77	4.8	\$ 468
	Peninsula Worksurfaces				
	62"W x 24"D, Right 62"W x 24"D, Left (shown)	SWP2462RP SWP2462LP	77 77	4.8 4.8	\$ 564 \$ 564
	P-shaped Worksurfaces				
	62"W x 24"/30"D P-shaped Peninsula, Right 62"W x 30"/24"D P-shaped Peninsula, Left (shown)	SWBAB62RP SWBAB62LP	82 82	6.2 6.2	\$ 602 \$ 602

Requires Support Column NCNLEG29

Requires Support Column NCNLEG29

GSA — Above models receive Other Filing & Storage discounting.

Description	Model	Ship Weight	Cube	List by Paint Grade	
				Core	Choice/Metallic "2"
Support Column* Required for Peninsula Worksurfaces for 29½" Height *Brackets must be connected into panel slots. Specify: Core: Black (P), Carob (V), Charcoal (S), Greige (T5), Light Gray (Q), Muslin (T3), Putty (L), Taupe (E) Choice/Metallics: Champagne Metallic (T4), Platinum Metallic (T1)	NCNLEG29	13 	1.1	\$ 150	\$ 175

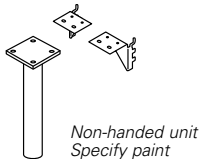

SIN 711-1

**SPECIFY: Model.Laminate/PVC
Model/Paint Grade "2".Paint**

**EXAMPLES: SWR2438P.JS
NCNLEG292.T1**

Flagship® End Tower with Bookcase

GSA SIN 711-3

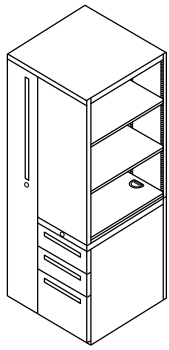

- ▶ **NEW!** Choice/Metallic and Custom paint options.
- ▶ See specifying information below for Choice/Metallic paint and pages 9 and 337 for Custom paint ordering instructions.
- ▶ Steel ball bearing suspension on box and file drawers.
- ▶ Each box drawer contains one divider, file drawers contain one follower block and one crossrail.
- ▶ 24"W x 24"D footprint allows use within systems applications by matching 24"D worksurfaces.
- ▶ Equipped with HON "One Key" interchangeable core removable locks.
- ▶ Four adjustable leveling glides.
- ▶ See page 357 for pedestal accessories.
- ▶ Arch pull available in Satin Chrome only.
- ▶ Choose from any of three pull options with no upcharge.
- ▶ See the HON October 2008 New Product pricer for new 48½"H Flagship Personal Storage Towers.
- ▶ Omit lock-option available. See page 463 for ordering instructions.
- ▶ Choose paint/color grades. See pages 336 and 337 for paint options.
- ▶ Meets or exceeds ANSI/BIFMA and ISTA performance standards.

Suffix "A"



Suffix "N"

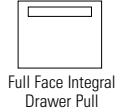

Suffix "R"



ONE KEY Refer to page 463

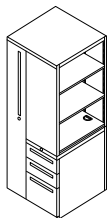

Model ST25723RN shown

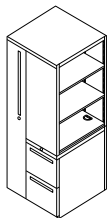

Model ST25823RN shown

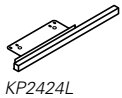

Description	Model	Ship Weight	Cube	List by Paint Grade		
				Choice/ Core	Custom "2"	Custom "3"
24"W x 24"D x 64¼"H End Tower with Bookcase, Box/Box/File, Bookcase on Right	ST25723R(?)	203	26.6	\$1698	\$1758	\$1818
24"W x 24"D x 64¼"H End Tower with Bookcase, Box/Box/File, Bookcase on Left NOTES: Wardrobe side measures 9"W x 24"D and includes a coat rod. Bookcase includes three adjustable shelves which adjust in ½" increments with wire management grommet in bottom shelf. Wardrobe and pedestal lock independently.	ST25723L(?)	203	26.6	\$1698	\$1758	\$1818
24"W x 24"D x 64¼"H End Tower with Bookcase, File/File, Bookcase on Right	ST25823R(?)	200	26.6	\$1698	\$1758	\$1818
24"W x 24"D x 64¼"H End Tower with Bookcase, File/File, Bookcase on Left NOTES: Wardrobe side measures 9"W x 24"D and includes a coat rod. Bookcase includes three adjustable shelves which adjust in ½" increments with wire management grommet in bottom shelf. Wardrobe and pedestal lock independently.	ST25823L(?)	200	26.6	\$1698	\$1758	\$1818
Flush Front Kick Plate for 24"W Towers NOTES: Mounts to base of tower to provide a flush appearance to coordinate with laterals and file centers. Kick plate is field-installable. Model KP2424R to be used on Personal Storage Tower with pedestal on right. Model KP2424L to be used on Personal Storage Tower with pedestal on left.	KP2424R KP2424L	2	0.1	\$ 99	\$ 104	\$ 109

GSA — Entire page receives Other Filing & Storage discounting.

NOTE: See page 357 for Pedestal Accessories.

- Omit lock core.
- Shippable by small-package carrier.

SPECIFY: Model (Pull).Paint
 Model (Pull)/Paint Grade "2".Paint
 Model (include omit lock X)(Pull).Paint
 Model (include omit lock X)(Pull)/Paint Grade "2".Paint

EXAMPLES: ST25723RA.P
 ST25723RA2.T1
 ST25723RXA.P
 S25723RXA2.T1

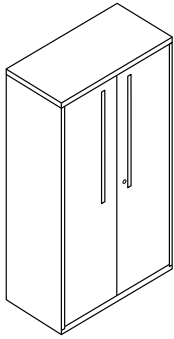

- ▶ **NEW!** Choice/Metallic and Custom paint options.
- ▶ See specifying information below for Choice/Metallic paint and pages 9 and 337 for Custom paint ordering instructions.
- ▶ 64 1/4"H models complement Initiate panel and Flagship lateral file heights.
- ▶ Flush top and sides.
- ▶ Reinforced case construction.
- ▶ Includes adjustable shelves, adjustable in 2" increments.
- ▶ Arch pull available in Satin Chrome only.
- ▶ Adjustable leveling glide is standard.
- ▶ Equipped with HON "One Key" interchangeable core removable locks.
- ▶ Wire management grommet in back of unit.
- ▶ Omit lock-option available. See page 463 for ordering instructions.
- ▶ Choose from any of three pull options with no upcharge.

Suffix "A"



Arch Pull

Suffix "N"

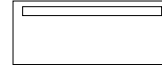

Full Face Integral Drawer Pull

Suffix "R"

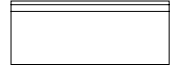





Full Radius Drawer Pull

- ▶ Choose paint/color grades. See pages 336 and 337 for paint options.
- ▶ Meets or exceeds ANSI/BIFMA and ISTA performance standards.

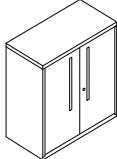

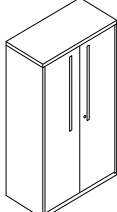
ONE KEY Refer to page 463

Description	Model	Ship Weight	Cube	List by Paint Grade		
				Core	Choice/Metallics "2"	Custom "3"
Storage Cabinets 36"W x 18"D x 39 1/8"H (with lock) 2 adjustable shelves  Model FSC183640N shown	FSC183640(?) 	119	20.0	\$ 726	\$ 786	\$ 846
36"W x 18"D x 64 1/4"H (with lock) 4 adjustable shelves  Model FSC183664N shown	FSC183664(?) 	184	31.8	\$1062	\$1122	\$1182

GSA — Above models receive Other Filing & Storage discounting.

 Omit lock core.

SPECIFY: Model (Pull).Paint
 Model (Pull)/Paint Grade "2".Paint
 Model (include omit lock X)(Pull).Paint
 Model (include omit lock X)(Pull)/Paint Grade "2".Paint

EXAMPLES: FSC183640A.P
 FS183640A2.T1
 FSX183640A.P
 FX183640A2.T1

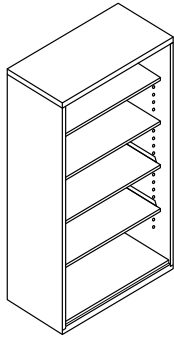

- ▶ **NEW!** Choice/Metallic and Custom paint options.
- ▶ See specifying information below for Choice/Metallic paint and pages 9 and 337 for Custom paint ordering instructions.
- ▶ 64¼"H models complement Initiate panel and Flagship lateral file heights.
- ▶ Flush top and sides.
- ▶ Reinforced case construction.
- ▶ Shelves adjust in 2" increments.
- ▶ Wire management grommet in back of unit.
- ▶ Choose paint/color grades. See pages 336 and 337 for paint options.
- ▶ Meets or exceeds ANSI/BIFMA and ISTA performance standards.



systems desk

seating

storage & files

tables

education

accessories

index

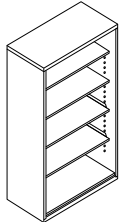
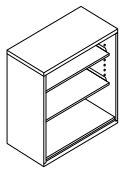

Description	Model	Ship Weight	Cube	List by Paint Grade		
				Choice/ Core	Custom Metallics "2"	Custom "3"
3 Shelf 36"W x 18"D x 39½"H	FSC183640W	100	20.0	\$ 587	\$ 617	\$ 647
5 Shelf 36"W x 18"D x 64¼"H	FSC183664W	148	31.8	\$ 869	\$ 929	\$ 989

GSA — Above models receive Other Filing & Storage discounting.

SPECIFY: Model.Paint
Model/Paint Grade "2".Paint

EXAMPLES: FSC183640W.P
FS183640W2.T1

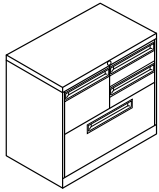

- ▶ **NEW!** Choice/Metallic and Custom paint options.
- ▶ See specifying information below for Choice/Metallic paint and pages 9 and 337 for Custom paint ordering instructions.
- ▶ 28"H File Center fit under standard Initiate, 38000 Series and worksurfaces.
- ▶ 27¼"H File Center fit under minimum worksurface height of 28½"H.
- ▶ Box and file drawer locations can be switched in the field.
- ▶ Steel ball bearing suspension on all drawers.
- ▶ Choose from any of four pull options with no upcharge.
- ▶ Includes 2 box drawer dividers, follower block and crossrail in file drawer and 1 set of lateral file hangrails for side-to-side filing.
- ▶ One cam lock located in center of top secures all drawers.
- ▶ Equipped with HON "One Key" interchangeable core removable lock.
- ▶ See page 368 for accessories.
- ▶ Arch pull available in Satin Chrome only.
- ▶ Omit lock-option available. See page 463 for ordering instructions.
- ▶ Choose paint/color grades. See pages 336 and 337 for paint options.
- ▶ Meets or exceeds ANSI/BIFMA and ISTA performance standards.

Suffix "A"



Arch Pull

Suffix "K"

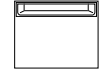

38000 Series Style Drawer Pull

Suffix "N"



Full Face Integral Drawer Pull

Suffix "R"



Full Radius Drawer Pull



ONE KEY Refer to page 463

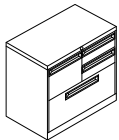

Model FC18730LK shown

Description	Model	Ship Weight	Cube	List by Paint Grade		
				Core	Choice/Metallics "2"	Custom "3"
30"W x 18"D x 28"H (Standard Height) File/Box/Box/Lateral	FC18730L(?)	140	12.5	\$1059	\$1089	\$1119
30"W x 18"D x 27¼"H (Universal Height) File/Box/Box/Lateral	FC16730L(?)	138	12.2	\$1059	\$1089	\$1119

NOTE: 1 file drawer, 2 box drawers and 1 lateral file drawer.

GSA — Above models receive Other Filing & Storage discounting.

For additional File Center solutions please see the HON October 2008 New Product pricer.

NOTE: See page 368 for Lateral File Accessories.

Omit lock core.

SPECIFY: Model (Pull).Paint
 Model (Pull)/Paint Grade "2".Paint
 Model (include omit lock core X)(Pull).Paint
 Model (include omit lock X)(Pull)/Paint Grade "2".Paint

EXAMPLES: FC18730LA.P
 FC18730LA2.T1
 FC18730XA.P
 FC18730XA2.T1

Flagship® Side Access Pedestals

GSA CONTRACT PENDING

HON
Smart now. Smarter later.

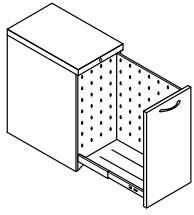

- ▶ **NEW!** Side Access Pedestal.
- ▶ Simple and personalized storage of multiple items.
- ▶ "Pantry-style" pull-out drawer provides simple access to stored items.
- ▶ Two ways to order Side Access Pedestals — accessories already included, or customized by specifying the accessories to fit your needs.
- ▶ **See page 347 for Accessory options.**
- ▶ Equipped with HON "One Key" interchangeable core removable locks.
- ▶ Pedestals are mobile and have an additional "fifth" wheel below the drawer front to provide stability.
- ▶ Omit lock-option available. See page 463 for ordering instructions.
- ▶ Accessories are adjustable in 3" increments along back and sides of drawer.
- ▶ 28"H fit under all HON worksurfaces and desk shells.
- ▶ Steel ball bearing suspension slides with 100% extension.
- ▶ Available in right or left-hand configurations.
- ▶ Available in three Flagship pull options.
- ▶ Choose paint/color grades. See pages 336 and 337 for paint options.
- ▶ Meets or exceeds ANSI/BIFMA and ISTA performance standards.

Suffix "A"



Satin Chrome

Suffix "N"



Full Face Integral Drawer Pull

Suffix "R"



Full Radius Drawer Pull



ONE KEY Refer to page 463

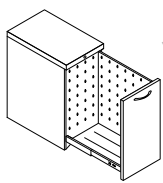

NEW!

Side Access Pedestal — Left
22⁷/₈"D x 15"W x 28"H
Pedestal only — accessories ordered separately.

Description	Model	Ship Weight	Cube	List by Paint Grade		
				Core	Choice/ Metallics "2"	Custom "3"
Side Access Pedestal — Left 22 ⁷ / ₈ "D x 15"W x 28"H Pedestal only — accessories ordered separately.	S28820L(?)	94	8.0	\$ 489	\$ 514	\$ 539

Model S28820RA shown

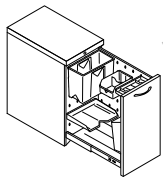

NEW!

Side Access Pedestal — Right
22⁷/₈"D x 15"W x 28"H
Pedestal only — accessories ordered separately.

Side Access Pedestal — Right 22 ⁷ / ₈ "D x 15"W x 28"H Pedestal only — accessories ordered separately.	S28820R(?)	94	8.0	\$ 489	\$ 514	\$ 539
--	-------------------	----	-----	--------	--------	--------

Model S28821RA shown

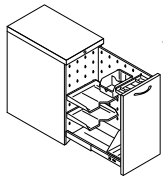

NEW!

Side Access Pedestal — Left
includes File Tub, CD/DVD Holder, Pencil Tray, Piling Tray, Folder Bin
22⁷/₈"D x 15"W x 28"H

Side Access Pedestal — Left includes File Tub, CD/DVD Holder, Pencil Tray, Piling Tray, Folder Bin 22 ⁷ / ₈ "D x 15"W x 28"H	S28821L(?)	98	8.0	\$ 577	\$ 602	\$ 627
--	-------------------	----	-----	--------	--------	--------

Side Access Pedestal — Right
includes File Tub, CD/DVD Holder, Pencil Tray, Piling Tray, Folder Bin
22⁷/₈"D x 15"W x 28"H

Side Access Pedestal — Right includes File Tub, CD/DVD Holder, Pencil Tray, Piling Tray, Folder Bin 22 ⁷ / ₈ "D x 15"W x 28"H	S28821R(?)	98	8.0	\$ 577	\$ 602	\$ 627
---	-------------------	----	-----	--------	--------	--------

Model S28822RA shown



NEW!

Side Access Pedestal — Left
includes Binder Storage, CD/DVD Holder, Pencil Tray, 2 Piling Trays
22⁷/₈"D x 15"W x 28"H

Side Access Pedestal — Left includes Binder Storage, CD/DVD Holder, Pencil Tray, 2 Piling Trays 22 ⁷ / ₈ "D x 15"W x 28"H	S28822L(?)	98	8.0	\$ 577	\$ 602	\$ 627
---	-------------------	----	-----	--------	--------	--------

Side Access Pedestal — Right
includes Binder Storage, CD/DVD Holder, Pencil Tray, 2 Piling Trays
22⁷/₈"D x 15"W x 28"H

Side Access Pedestal — Right includes Binder Storage, CD/DVD Holder, Pencil Tray, 2 Piling Trays 22 ⁷ / ₈ "D x 15"W x 28"H	S28822R(?)	98	8.0	\$ 577	\$ 602	\$ 627
--	-------------------	----	-----	--------	--------	--------

NOTE: See page 347 for Accessories.

Omit lock core.

How to specify	1st Option:	2nd Option:
<p>Select the Model Number from above.</p> <p>Select the Pull:</p> <p>A Satin Pull N Full Face Integral R Full Radius</p>	<p>Select the Lock Option:</p> <p>L Lock X Omit Lock (deduct \$14)</p>	<p>Select the Paint Color:</p> <p>See pages 336-337 for paint options. See page 9 and 337 for Custom paint ordering instructions.</p>
S 2 8 8 2 0 L A	L .	T 1

SPECIFY: Model/Pull.Lock.Paint Grade.Paint

EXAMPLE: S28820LA.L.T1

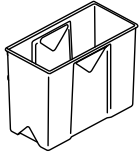













▶ **NEW!** Side Access Pedestal Accessories.

▶ Compatible with Flagship Side Access Pedestal. See page 346 for pedestal information.

▶ All parts are available in translucent plastic only.

▶ Meets or exceeds ANSI/BIFMA and ISTA performance standards.

	Description	Dimensions	Model	Ship Weight	Cube	List
 NEW!	File Tub	12 ⁵ / ₁₆ "W x 6 ¹ / ₄ "D x 9 ¹ / ₁₆ "H	S2801	2 	.3	\$ 40
 NEW!	Binder Storage	5 ¹ / ₂ "W x 11 ¹³ / ₁₆ "D x 11 ¹ / ₂ "H	S2802	2 	.3	\$ 35
 NEW!	CD/DVD Holder	5 ⁵ / ₁₆ "W x 7 ³ / ₄ "D x 3 ³ / ₄ "H	S2803	1 	.2	\$ 20
 NEW!	Pencil Tray	10 ¹ / ₄ "W x 3 ³ / ₄ "D x 1 ¹ / ₈ "H	S2806	1 	.2	\$ 15
 NEW!	Piling Shelf	11 ¹ / ₂ "W x 9 ¹ / ₄ "D x 2"H	S2807	1 	.3	\$ 20
 NEW!	Folder Bin	12 ⁵ / ₁₆ "W x 3 ¹ / ₂ "D x 10 ⁷ / ₁₆ "H	S2809	2 	.3	\$ 30

 Shippable by small-package carrier.

Flagship® Universal Height Pedestals

GSA SIN 711-1, 711-2

HON
Smart now. Smarter later.

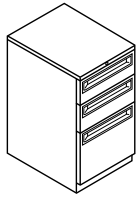

- ▶ **NEW!** Choice/Metallic and Custom paint options.
- ▶ See specifying information below for Choice/Metallic paint and pages 9 and 337 for Custom paint ordering instructions.
- ▶ 26⁷/₈"H pedestals fit under minimum worksurface height of 28¹/₂"H.
- ▶ Pencil tray standard in top box drawer.
- ▶ One drawer divider standard in each box drawer.
- ▶ One follower block and one crossrail standard in each file drawer.
- ▶ Steel ball bearing suspension on file drawer (full extension), and box drawer (90% extension).
- ▶ Double-wall drawer construction.
- ▶ File drawers have high sides for filing front-to-back.
- ▶ See page 357 for accessories and pedestal utilization information.
- ▶ Equipped with HON "One Key" interchangeable core removable locks.
- ▶ Counterweight standard in mobile pedestals.
- ▶ Arch pull available in Satin Chrome only.
- ▶ Choose from any of four pull options with no upcharge.
- ▶ **Freestanding support pedestals that are not positioned and attached under a worksurface, require a counterweight kit found on page 357.**
- ▶ Omit lock-option available. See page 463 for ordering instructions.
- ▶ Choose paint/color grades. See pages 336 and 337 for paint options.
- ▶ Meets or exceeds ANSI/BIFMA and ISTA performance standards.

Suffix "A"



Satin Chrome

Suffix "K"

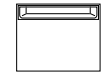

38000 Series Style Drawer Pull

Suffix "N"

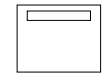

Full Face Integral Drawer Pull

Suffix "R"

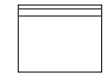

Full Radius Drawer Pull



ONE KEY Refer to page 463

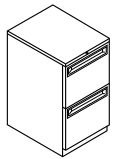
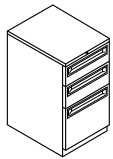
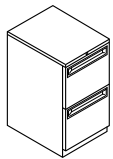
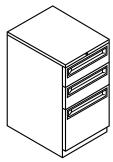

Description	Model	Ship Weight	Cube	List by Paint Grade		
				Choice/ Core	Metallics "2"	Custom "3"
Universal Height Mobile Pedestals — Box/Box/File						
26 ⁷ / ₈ "H x 19 ⁷ / ₈ "D x 15"W	16720(?)	84	7.0	\$ 473	\$ 498	\$ 523
26 ⁷ / ₈ "H x 22 ⁷ / ₈ "D x 15"W	16723(?)	88	8.0	\$ 491	\$ 516	\$ 541
26 ⁷ / ₈ "H x 28 ⁷ / ₈ "D x 15"W	16730(?)	102	9.8	\$ 519	\$ 544	\$ 569
Universal Height Mobile Pedestals — File/File						
26 ⁷ / ₈ "H x 19 ⁷ / ₈ "D x 15"W	16820(?)	80	7.0	\$ 473	\$ 498	\$ 523
26 ⁷ / ₈ "H x 22 ⁷ / ₈ "D x 15"W	16823(?)	85	8.0	\$ 491	\$ 516	\$ 541
26 ⁷ / ₈ "H x 28 ⁷ / ₈ "D x 15"W	16830(?)	98	9.8	\$ 519	\$ 544	\$ 569
Universal Height Freestanding Support Pedestals — Box/Box/File						
26 ⁷ / ₈ "H x 19 ⁷ / ₈ "D x 15"W	17720(?)	69	7.0	\$ 473	\$ 498	\$ 523
26 ⁷ / ₈ "H x 22 ⁷ / ₈ "D x 15"W	17723(?)	73	8.0	\$ 491	\$ 516	\$ 541
26 ⁷ / ₈ "H x 28 ⁷ / ₈ "D x 15"W	17730(?)	87	9.8	\$ 519	\$ 544	\$ 569
Universal Height Freestanding Support Pedestals — File/File						
26 ⁷ / ₈ "H x 19 ⁷ / ₈ "D x 15"W	17820(?)	65	7.0	\$ 473	\$ 498	\$ 523
26 ⁷ / ₈ "H x 22 ⁷ / ₈ "D x 15"W	17823(?)	70	8.0	\$ 491	\$ 516	\$ 541
26 ⁷ / ₈ "H x 28 ⁷ / ₈ "D x 15"W	17830(?)	83	9.8	\$ 519	\$ 544	\$ 569

GSA — Entire page receives Initiate Panel System discounting.

Flagship®/Brigade™ Series Pedestals Utilization with 38000 Series, Initiate®, 66000 Series and Simplicity® II.

PEDESTAL DEPTHS	INITIATE® AND SIMPLICITY II PANEL-HUNG WORKSURFACES				66000 STATIONMASTER		38000 SERIES MODULAR DESKING		
	20" DEEP	24" DEEP	29 ¹ / ₂ " DEEP	30" DEEP	24" DEEP	29 ¹ / ₂ " DEEP	24" DEEP	30" DEEP	36" DEEP
19 ⁷ / ₈ DEEP	X	X	X	X	X	X	X	X	X
22 ⁷ / ₈ DEEP		X	X	X		X	X*	X	X
28 ⁷ / ₈ DEEP			X	X				X	X

*Cannot attach to 22⁷/₈"D Hanging Pedestal.

NOTE: See Brigade™ and Embark™ pedestals on pages 355-356 for additional pedestal options. See page 357 for Pedestal Accessories.

Omit lock core.

SPECIFY: Model (Pull).Paint
 Model/Paint Grade "2".Paint
 Model (include omit lock X)(Pull).Paint
 Model (include omit lock X)(Pull)/Paint Grade "2".Paint

EXAMPLES: 16720A.P
 16720A2.T1
 16720XA.P
 16720XA2.T1

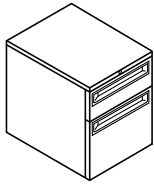

- ▶ **NEW!** Choice/Metallic and Custom paint options.
- ▶ 28"H fits under all HON worksurfaces and desk shells.
- ▶ Pencil tray standard in top box drawer.
- ▶ One drawer divider standard in each box drawer.
- ▶ One follower block and one crossrail standard in each file drawer.
- ▶ Steel ball bearing suspension on file drawer (full extension), and box drawer (90% extension).
- ▶ Double-wall drawer construction.
- ▶ File drawers have high sides for filing front-to-back.
- ▶ See page 357 for accessories and pedestal utilization information.
- ▶ Equipped with HON "One Key" interchangeable core removable locks.
- ▶ Hanging units are mounted using keyhole slots in top of pedestals; all hardware provided.
- ▶ Arch pull available in Satin Chrome only.
- ▶ Choose from any of four pull options with no upcharge.
- ▶ Counterweight standard in mobile pedestals.
- ▶ **Freestanding support pedestals that are not positioned and attached under a worksurface, require a counterweight kit found on page 357.**
- ▶ Omit lock-option available. See page 463 for ordering instructions.
- ▶ Choose paint/color grades. See pages 336 and 337 for paint options.
- ▶ Meets or exceeds ANSI/BIFMA and ISTA performance standards.

Suffix "A"



Arch Pull

Suffix "K"

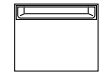

38000 Series Style Drawer Pull

Suffix "N"



Full Face Integral Drawer Pull

Suffix "R"



Full Radius Drawer Pull



ONE KEY Refer to page 463

	Description	Model	Ship Weight	Cube	List by Paint Grade		
					Core	Choice/Metallics "2"	Custom "3"
	Hanging Pedestals — Box/File						
	19½"H x 19¾"D x 15"W	14920(?)	44	5.3	\$ 405	\$ 430	\$ 455
	19½"H x 22¾"D x 15"W	14923(?)	48	6.0	\$ 422	\$ 447	\$ 472
	Standard Height Mobile Pedestals — Box/Box/File						
	28"H x 19¾"D x 15"W	18720(?)	84	7.0	\$ 517	\$ 542	\$ 567
	28"H x 22¾"D x 15"W	18723(?)	88	8.0	\$ 535	\$ 560	\$ 585
	28"H x 28¾"D x 15"W	18730(?)	102	9.8	\$ 563	\$ 588	\$ 613
	Standard Height Mobile Pedestals — File/File						
	28"H x 19¾"D x 15"W	18820(?)	80	7.0	\$ 517	\$ 542	\$ 567
	28"H x 22¾"D x 15"W	18823(?)	85	8.0	\$ 535	\$ 560	\$ 585
	28"H x 28¾"D x 15"W	18830(?)	98	9.8	\$ 563	\$ 588	\$ 613
	Standard Height Freestanding Support Pedestals — Box/Box/File						
	28"H x 19¾"D x 15"W	19720(?)	69	7.0	\$ 517	\$ 542	\$ 567
	28"H x 22¾"D x 15"W	19723(?)	73	8.0	\$ 535	\$ 560	\$ 585
	28"H x 28¾"D x 15"W	19730(?)	87	9.8	\$ 563	\$ 588	\$ 613
	Standard Height Freestanding Support Pedestals — File/File						
	28"H x 19¾"D x 15"W	19820(?)	65	7.0	\$ 517	\$ 542	\$ 567
	28"H x 22¾"D x 15"W	19823(?)	70	8.0	\$ 535	\$ 560	\$ 585
	28"H x 28¾"D x 15"W	19830(?)	83	9.8	\$ 563	\$ 588	\$ 613

GSA — Entire page receives Initiate Panel System discounting.

NOTE: See Brigade™ and Embark™ pedestals on pages 355-356 for additional pedestal options. See page 357 for Pedestal Accessories.

Omit lock core.

SPECIFY: Model (Pull).Paint
 Model/Paint Grade "2".Paint
 Model (include omit lock X)(Pull).Paint
 Model (include omit lock X)(Pull)/Paint Grade "2".Paint

EXAMPLES: 14920A.P
 14920A2.T1
 14920XA.P
 14920XA2.T1

Flagship® Universal and Standard Height Multi-Shift Pedestals

GSA
SIN 711-1, 711-2

HON
Smart now. Smarter later.

- ▶ **NEW!** Choice/Metallic and Custom paint options.
- ▶ See specifying information below for Choice/Metallic paint and pages 9 and 337 for Custom paint ordering instructions.
- ▶ 26 $\frac{3}{8}$ "H pedestals fit under minimum worksurface height of 28 $\frac{1}{2}$ "H.
- ▶ One follower block and one crossrail standard in each file drawer.
- ▶ Steel ball bearing suspension on file drawer (full extension).
- ▶ Double-wall drawer construction.
- ▶ File drawers have high sides for filing front-to-back.
- ▶ Each drawer locks independently for security.
- ▶ See page 357 for accessories and pedestal utilization information.
- ▶ Equipped with HON "One Key" interchangeable core removable locks.
- ▶ Counterweight standard in mobile pedestals.
- ▶ Omit lock-option available. See page 463 for ordering instructions.
- ▶ **Freestanding support pedestals that are not positioned and attached under a worksurface, require a counterweight kit found on page 357.**
- ▶ Choose paint/color grades. See pages 336 and 337 for paint options.
- ▶ Meets or exceeds ANSI/BIFMA and ISTA performance standards.







Suffix "R"

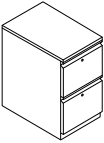

Full Radius
Drawer Pull

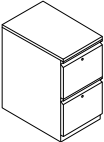

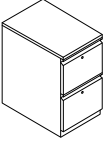
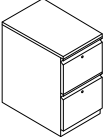
ONE KEY Refer to page 463

	Description	Model	Ship Weight	Cube	List by Paint Grade		
					Core	Choice/Metallics "2"	Custom "3"
	Universal Height Mobile Pedestals — File/File 26 $\frac{3}{8}$ "H x 22 $\frac{1}{8}$ "D x 15"W	16823RH 	85	8.0	\$ 565	\$ 590	\$ 615
	Standard Height Mobile Pedestals — File/File 28"H x 22 $\frac{1}{8}$ "D x 15"W	18823RH 	85	8.0	\$ 565	\$ 590	\$ 615
	Universal Height Freestanding Support Pedestals — File/File 26 $\frac{3}{8}$ "H x 22 $\frac{1}{8}$ "D x 15"W	17823RH 	70	8.0	\$ 565	\$ 590	\$ 615
	Standard Height Freestanding Support Pedestals — File/File 28"H x 22 $\frac{1}{8}$ "D x 15"W	19823RH 	70	8.0	\$ 565	\$ 590	\$ 615

GSA — Entire page receives Initiate Panel System discounting.

NOTE: See Brigade™ and Embark™ pedestals on pages 355-356 for additional pedestal options. See page 357 for Pedestal Accessories.

 Omit lock core.

SPECIFY: Model.Paint
Model/Paint Grade "2".Paint
Model (include omit lock X).Paint
Model (include omit lock X)(Pull)/Paint Grade "2".Paint

EXAMPLES: 16823RH.S
16823RH2.T1
16823XRH.S
16823XRH2.T1

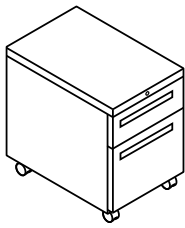

- ▶ **NEW!** Choice/Metallic and Custom paint options.
- ▶ See specifying information below for Choice/Metallic paint and pages 9 and 337 for Custom paint ordering instructions.
- ▶ Pencil tray standard in top box drawer.
- ▶ One drawer divider standard in each box drawer.
- ▶ One follower block and one crossrail standard in each file drawer.
- ▶ File drawers have high sides for filing front-to-back.
- ▶ Steel ball bearing suspension on file drawer, and box drawer.
- ▶ Double-wall drawer construction.
- ▶ See page 357 for accessories and pedestal utilization information.
- ▶ Arch pull available in Satin Chrome only.
- ▶ Choose from any of four pull options with no upcharge.
- ▶ Choose paint/color grades. See pages 336 and 337 for paint options.
- ▶ Equipped with HON "One Key" interchangeable core removable locks.
- ▶ Counterweight standard.
- ▶ Omit lock-option available. See page 463 for ordering instructions.
- ▶ Meets or exceeds ANSI/BIFMA and ISTA performance standards.

Suffix "A"



Arch Pull

Suffix "K"

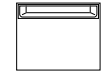

38000 Series Style Drawer Pull

Suffix "N"



Full Face Integral Drawer Pull

Suffix "R"

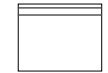

Full Radius Drawer Pull



ONE KEY Refer to page 463

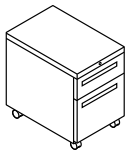

15923N
SIN 711-1

Description

Mobile Pedestals — Box/File
22"H x 22 7/8"D x 15"W

Model

15923(?)

Ship Weight

92

Cube

6.0

List by Paint Grade

Core Choice/Metallics "2" Custom "3"

\$ 419 \$ 444 \$ 469

GSA — Above model receives Initiate Panel System discounting.

Description

Pedestal Seat

Size

22 7/8"D x 15"W

Model

PSEAT24

Ship Weight

10

Cube

1.2

Price Code

III \$ 199
IV \$ 212
V \$ 224
FC2 \$ 238
M1 \$ 233
M2 \$ 238
M3 \$ 243

NOTE: For seating fabrics, see pages 274-279.
Not available in BK, EC, EE, EG, EJ, SR, SS and WP fabrics.

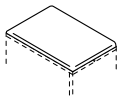

SIN 711-2

Description

Mobile Pedestal Tray

Size

22 7/8"D x 15"W x 1 1/8"H

Model

PTRAY

Ship Weight

13

Cube

1.2

\$ 367

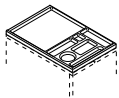

SIN 711-2

Description

Mobile Pedestal Handle 20"D x 15"W

Model

PHANDLE

Ship Weight

7

Cube

0.7

\$ 146

- Specify paint color — Platinum Metallic (T1) only.

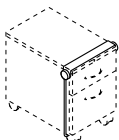

SIN 711-2

NOTE: See Brigade™ and Embark™ pedestals on pages 355-356 for additional pedestal options. See page 357 for Pedestal Accessories.

- Omit lock core.
- Shippable by small-package carrier.

SPECIFY: Model (Pull).Paint
Model/Paint Grade "2".Paint
Model (include omit lock X)(Pull).Paint
Model (include omit lock X)(Pull)/Paint Grade "2".Paint

EXAMPLES: 15923A.P
15923A2.T1
15923XA.P
15923XA2.T1

Flagship® 18" Deep Lateral Files with Drawers



GSA SIN 711-3

HON
Smart now. Smarter later.

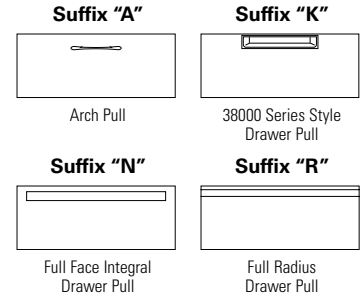
- ▶ **NEW!** Choice/Metallic and Custom paint options.
- ▶ See specifying information below for Choice/Metallic paint and pages 9 and 337 for Custom paint ordering instructions.
- ▶ 27¼"H lateral file fit under minimum worksurface height of 28½"H.
- ▶ 28"H lateral fit under standard Initiate, 38000 Series and worksurfaces.
- ▶ 5 Drawer model complements Initiate® and Simplicity® II Panel heights.
- ▶ Flush top and sides.
- ▶ Reinforced case construction.
- ▶ Lock mechanism serves both sides of drawer.
- ▶ Equipped with HON "One Key" interchangeable core removable locks.
- ▶ Counterweight included where applicable to meet ANSI/BIFMA stability requirements.
- ▶ Three-part, telescoping, steel ball-bearing suspension.
- ▶ Features drawer extension restraint; mechanical interlock inhibits the extension of more than one drawer at a time.
- ▶ Magnetic label holders supplied with each unit.
- ▶ Flush top and sides.
- ▶ Optional laminate tops and accessories — see page 368.
- ▶ Matching Pedestals — see pages 348-350.
- ▶ Optional Posting Shelf on five-opening units.
- ▶ Omit lock-option available. See page 463 for ordering instructions.
- ▶ Arch pull available in Satin Chrome only.
- ▶ Choose from any of four pull options with no upcharge.
- ▶ Choose paint/color grades. See pages 336 and 337 for paint options.
- ▶ Meets or exceeds ANSI/BIFMA and ISTA performance standards.

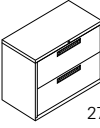
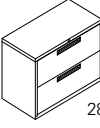

ONE KEY Refer to page 463

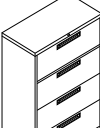
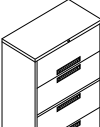
Description	Model	Ship Weight	Cube	List by Paint Grade			
				Core	Choice/Metallics "2"	Custom "3"	
 27¼"H – Universal Height	30"W x 18"D 2 Drawer	9172(?)	138	12.3	\$ 692	\$ 722	\$ 752
	36"W x 18"D 2 Drawer	9182(?)	156	14.5	\$ 765	\$ 795	\$ 825
	42"W x 18"D 2 Drawer	9192(?)	177	16.8	\$ 887	\$ 917	\$ 947
 28"H – Standard Height	30"W x 18"D 2 Drawer	9170(?)	138	12.3	\$ 692	\$ 722	\$ 752
	36"W x 18"D 2 Drawer	9180(?)	156	14.5	\$ 765	\$ 795	\$ 825
	42"W x 18"D 2 Drawer	9190(?)	177	16.8	\$ 887	\$ 917	\$ 947
 39½"H	30"W x 18"D 3 Drawer	9173(?)	150	16.9	\$ 909	\$ 939	\$ 969
	36"W x 18"D 3 Drawer	9183(?)	174	20.0	\$1022	\$1052	\$1082
	42"W x 18"D 3 Drawer	9193(?)	197	23.2	\$1181	\$1211	\$1241
 52½"H	30"W x 18"D 4 Drawer w/o Posting Shelf	9174(?)	176	22.1	\$1147	\$1207	\$1267
	36"W x 18"D 4 Drawer w/o Posting Shelf	9184(?)	198	26.2	\$1302	\$1362	\$1422
	42"W x 18"D 4 Drawer w/o Posting Shelf	9194(?)	213	30.3	\$1494	\$1554	\$1614
 64¼"H	30"W x 18"D 5 Drawer w/Posting Shelf	9275(?)	210	26.8	\$1495	\$1555	\$1615
	30"W x 18"D 5 Drawer w/o Posting Shelf	9175(?)	203	26.8	\$1464	\$1524	\$1584
	36"W x 18"D 5 Drawer w/Posting Shelf	9285(?)	245	31.8	\$1684	\$1744	\$1804
	36"W x 18"D 5 Drawer w/o Posting Shelf	9185(?)	238	31.8	\$1651	\$1711	\$1771
	42"W x 18"D 5 Drawer w/Posting Shelf	9295(?)	271	36.8	\$1945	\$2005	\$2065
	42"W x 18"D 5 Drawer w/o Posting Shelf	9195(?)	264	36.8	\$1915	\$1975	\$2035

NOTE: Top drawer is a roll-out shelf.

NOTE: See page 354 for Overfiles and page 368 for Lateral File Accessories.

 Omit lock core.

SPECIFY: Model.Paint
 Model/Paint Grade "2".Paint
 Model (include omit lock X).Paint
 Model (include omit lock X)(Pull)/Paint Grade "2".Paint

EXAMPLES: 9172A.P
 9172A2.T1
 9172XA.P
 9172XA2.T1

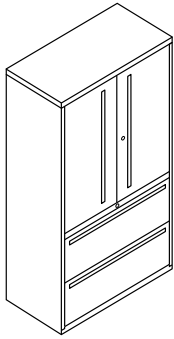

- ▶ **NEW!** Choice/Metallic and Custom paint options.
- ▶ See specifying information below for Choice/Metallic paint and pages 9 and 337 for Custom paint ordering instructions.
- ▶ 64¼"H models complement Initiate panel and Flagship lateral file heights.
- ▶ Equipped with HON "One Key" interchangeable core removable locks. Locks on storage cabinet doors and lateral file are keyed-alike.
- ▶ Three-part, telescoping, steel ball-bearing suspension.
- ▶ Includes two adjustable shelves, adjustable in 2" increments.
- ▶ Arch pull available in Satin Chrome only.
- ▶ Lock mechanism serves both sides of drawer.
- ▶ Features drawer extension restraint; mechanical interlock inhibits the extension of more than one drawer at a time.
- ▶ Wire management grommet in back of unit.
- ▶ Omit lock-option available. See page 463 for ordering instructions.

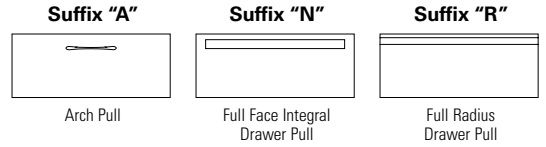

- ▶ Flush top and sides.
- ▶ Choose from any of three pull options with no upcharge.
- ▶ Choose paint/color grades. See pages 336 and 337 for paint options.
- ▶ Meets or exceeds ANSI/BIFMA and ISTA performance standards.



ONE KEY Refer to page 463

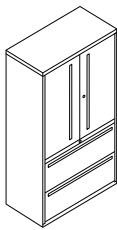

Model 9185LSN shown

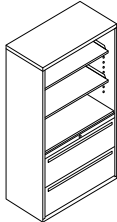

Model 9185LSNN shown

Description	Model	Ship Weight	Cube	List by Paint Grade		
				Core	Choice/Metallics "2"	Custom "3"
Lateral Files with Storage						
30"W x 18"D x 64¼"H (with hinged doors)	9175LS(?)	184	26.8	\$1372	\$1432	\$1492
36"W x 18"D x 64¼"H (with hinged doors)	9185LS(?)	203	31.8	\$1560	\$1620	\$1680
NOTE: Lateral File drawers lock independently from storage case.						
Lateral Files with Open Shelves						
30"W x 18"D x 64¼"H (with open shelves, no doors)	9175LSN(?)	167	26.8	\$1254	\$1314	\$1374
36"W x 18"D x 64¼"H (with open shelves, no doors)	9185LSN(?)	184	31.8	\$1422	\$1482	\$1542

GSA — Above models receive Other Filing & Storage discounting.

Omit lock core.

SPECIFY: Model (Pull).Paint
 Model/Paint Grade "2".Paint
 Model (include omit lock X)(Pull).Paint
 Model (include omit lock X)(Pull)/Paint Grade "2".Paint

EXAMPLES: 9175LSA.P
 9175LSA2.T1
 9175LSXA.P
 9175LSXA2.T1

Metal Overfiles

GSA SIN 711-3 Except as Noted

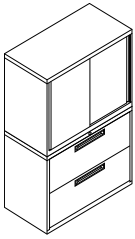

- ▶ **NEW!** Choice/Metallic and Custom paint options.
- ▶ See specifying information below for Choice/Metallic paint and pages 9 and 337 for Custom paint ordering instructions.
- ▶ Maximizes use of space above lateral files.
- ▶ One adjustable shelf per cabinet, adjustable at 1" increments, up to 6" from center position.
- ▶ Capable of accepting two tiers of 12"H binders (depending on shelf location).
- ▶ Can be used on the floor under 29½"H worksurfaces.
- ▶ Four wire dividers supplied per shelf (total 8 per unit) with locating slots every 3" along shelf and base.
- ▶ Units fasten to new or existing lateral file cabinets (attaching hardware included).
- ▶ Units can be attached to wall behind lateral file, and/or "ganged" together for added stability.
- ▶ Choose paint/color grades. See page 336 and 337 for paint options.
- ▶ Compatible with Flagship, 800, 700, 600, 500 and 400 Series Lateral Files.
- ▶ "Slide-by" door design does not intrude into office or aisle space.
- ▶ Optional core removable lock kit.
- ▶ Units are 18" deep, and available in 30", 36" and 42" widths.
- ▶ When fully opened, door opening is 13¼"W, 16¼"W or 19¼"W.
- ▶ Meets or exceeds applicable ANSI/BIFMA and ISTA performance standards.



ONE KEY Refer to page 463

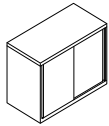

SIN 711-1, 711-3

Description	Model	Ship Weight	Cube	List by Paint Grade		
				Core	Choice/Metallics "2"	Custom "3"
30"W x 18"D x 27⅞"H One adjustable shelf	9317	74	11.4	\$ 596	\$ 626	\$ 656
36"W x 18"D x 27⅞"H One adjustable shelf	9318	85	13.5	\$ 641	\$ 671	\$ 701
42"W x 18"D x 27⅞"H One adjustable shelf	9319	96	15.6	\$ 681	\$ 711	\$ 741
<i>GSA — Above models receive Vertical, Lateral & Shelf File discounting.</i>						
Core Removable Lock Kit for Metal Overfiles NOTE: Keyed alike cores must be ordered separately — see page 463.	9310	2	0.5	\$ 60		
<i>GSA — Above model receives Vertical, Lateral & Shelf File discounting.</i>						

**SPECIFY: Model.Paint
Model/Paint Grade "2".Paint**

**EXAMPLES: 9317.P
93172.T1**

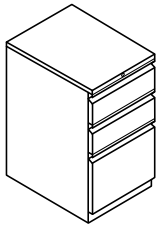

- ▶ **NEW!** Choice/Metallic and Custom paint options.
- ▶ See specifying information below for Choice/Metallic paint and pages 9 and 337 for Custom paint ordering instructions.
- ▶ 28"H fits under all HON worksurfaces and desk shells.
- ▶ Pencil tray standard in top box drawer.
- ▶ Two crossrails standard in each file drawer.
- ▶ Ball-bearing suspension on file drawer (90% extension), and box drawer (75% extension).
- ▶ File drawers have high sides for filing front-to-back.
- ▶ See page 357 for accessories and pedestal utilization information.
- ▶ Equipped with HON "One Key" interchangeable core removable locks.
- ▶ Front casters are fixed, rear casters swivel on mobile pedestals.
- ▶ "D" pull available in Black only.
- ▶ Choose paint/color grades. See page 336 and 337 for paint options.
- ▶ **Freestanding support pedestals that are not positioned and attached under a worksurface, require a counterweight kit found on page 357.**
- ▶ Meets or exceeds ANSI/BIFMA and ISTA performance standards.

Suffix "D"

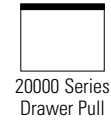

Suffix "R"

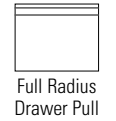

ONE KEY Refer to page 463

	Description	Model	Ship Weight	Cube	List by Paint Grade		
					Core	Choice/Metallics "2"	Custom "3"
	Standard Height Mobile Pedestals — Box/Box/File						
	28"H x 19 7/8"D x 15"W	33720(?)	73	6.6	\$ 459	\$ 484	\$ 509
	28"H x 22 7/8"D x 15"W	33723(?)	77	7.5	\$ 474	\$ 499	\$ 524
	Standard Height Mobile Pedestals — File/File						
	28"H x 19 7/8"D x 15"W	33820(?)	73	6.6	\$ 459	\$ 484	\$ 509
	28"H x 22 7/8"D x 15"W	33823(?)	77	7.5	\$ 474	\$ 499	\$ 524
	Standard Height Freestanding Support Pedestals — Box/Box/File						
	28"H x 19 7/8"D x 15"W	36720(?)	61	6.6	\$ 459	\$ 484	\$ 509
	28"H x 22 7/8"D x 15"W	36723(?)	83	7.5	\$ 474	\$ 499	\$ 524
	Standard Height Freestanding Support Pedestals — File/File						
	28"H x 19 7/8"D x 15"W	36820(?)	61	6.6	\$ 459	\$ 484	\$ 509
	28"H x 22 7/8"D x 15"W	36823(?)	83	7.5	\$ 474	\$ 499	\$ 524

GSA — Entire page receives Simplicity II Panel System discounting.

NOTE: See page 357 for Pedestal Accessories.
Additional Flagship pedestal models on pages 348-351.

See page 1.

SPECIFY: Model (Pull).Paint
Model/Paint Grade "2".Paint

EXAMPLE: 33720R.P
33720R2.T1

Embark™ Standard Height Pedestals with “M” Pull

GSA SIN 711-1, 711-2



- ▶ 28”H fits under all HON worksurfaces and desk shells.
- ▶ Pull complements 400 and 500 Series laterals and Metro Classic Series steel desks.
- ▶ Pull color matches paint selection.
- ▶ Embark formerly 1600 Series Pedestals.
- ▶ Feature-rich storage pedestals at an economical price.
- ▶ Mobile pedestals available in Box/Box/File and File/File drawer configurations.
- ▶ Equipped with HON “One Key” interchangeable core removable locks. Keyed alike cores must be ordered separately — see page 463.
- ▶ Box drawers feature nylon roller suspensions with 75% extension.
- ▶ File drawers feature 90% extension cradles with triple-tied suspensions.
- ▶ Hangrails are factory installed at no extra charge.
- ▶ See page 357 for F23C and F22 key options. Other accessories on pages 357 do not apply to Embark.
- ▶ Wire divider in box and file drawers.
- ▶ Mobile units have locking casters.
- ▶ Models meet or exceed ANSI/BIFMA and ISTA performance standards.



ONE KEY Refer to page 463



Description	Model	Ship Weight	Cube	List Core
Standard Height Mobile Pedestals — Box/Box/File 28”H x 20”D x 15”W 28”H x 23”D x 15”W	1623M	49	6.6	\$ 352
	1625M	56	7.5	\$ 372
Standard Height Mobile Pedestals — File/File 28”H x 20”D x 15”W 28”H x 23”D x 15”W	1624M	44	6.6	\$ 352
	1626M	51	7.5	\$ 372

GSA — Above models receive Simplicity II Panel System discounting.

NOTE: Additional Flagship pedestal models on pages 348-351.

See page 1.

SPECIFY: Model.Paint





EXAMPLE: 1623M.P

► **NEW!** Choice/Metallic and Custom paint options.









Flagship®/Brigade™ Series Pedestals Utilization with 38000 Series, Initiate®, 66000 Series and Simplicity® II.

PEDESTAL DEPTHS	INITIATE® AND SIMPLICITY II PANEL-HUNG WORKSURFACES			66000 STATIONMASTER		38000 SERIES MODULAR DESKING		
	20" DEEP	24" DEEP	29½" DEEP	24" DEEP	29½" DEEP	24" DEEP	30" DEEP	36" DEEP
19½" DEEP	X	X	X	X	X	X	X	X
22½" DEEP		X	X		X	X*	X	X
28½" DEEP			X				X	X

* Cannot attach 22½"D Hanging Pedestal.

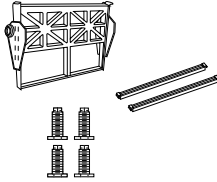
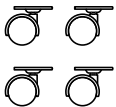
Description	Size	Model	Ship Weight	Cube	List by Paint Grade		
					Core	Choice/Metallics "2"	Custom "3"
	1¾"H x 19¾"D x 15"W	11620PC	6 	0.2	\$ 55	\$ 60	\$ 65
	1¾"H x 22¾"D x 15"W	11623PC	7 	0.3	\$ 66	\$ 71	\$ 76
	1¾"H x 28¾"D x 15"W	11630PC	8 	0.4	\$ 75	\$ 80	\$ 85
NOTE: Spacers are mounted on 26¾"H pedestals with optional glides when used to support a worksurface at 29½" high. Spacers can also be used as a cosmetic filler under 29½"H worksurfaces. Not for use with hanging pedestals.							

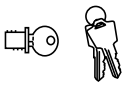
GSA — Above models receive Initiate Panel System discounting.

Description	Size	Model	Ship Weight	Cube	List
	19¾"D x 15"W	21520TP	13 	1.0	\$ 157
	22¾"D x 15"W	21523TP	15 	1.1	\$ 191
	28¾"D x 15"W	21529TP	19 	1.4	\$ 207
GSA — Above models receive Initiate Panel System discounting.					
Counterweight — Freestanding Support Pedestals		PCW1	18	0.1	\$ 120
	Follower Block — 1-Pack. Gray only.	F80	1	0.3	\$ 28
	Double-Rail Hanging File Racks — 2-Pack. Gray only (for side-to-side)	519495	.5	0.5	\$ 18
	Adjustable Glides — 4-Pack Field-installable, used to convert mobile pedestals to freestanding support pedestals. NOTE: Hardware included	20040AG	1	0.6	\$ 34
GSA — Above models receive Initiate Panel System discounting.					
	Caster Package — Field Installable Four Casters (2 swivel, 2 fixed)	1050CST	1 	0.6	\$ 25
	NOTE: Used to convert Freestanding Support Pedestals to Mobile Pedestals. May not be used on pedestals without a counterweight.	GSA — Above models receive Initiate Panel System discounting.			
	Lock Core Replacement Kit — Chrome (Specify quantity of each key number from 101E-225E.) Contains one core, two keys, one core removable tool and instructions. Refer to page 463. Master Key (one key) Available to authorized dealers only.	F23C	0.1 	0.1	\$ 23
		F22	0.1 	0.1	\$ 13
GSA — Above models receive Vertical, Lateral & Shelf File discounting.					

WORKING WITH STORAGE PEDESTALS

Storage Pedestals are available in 6 styles:

- Box/File Mobile(Model Nos. beginning in 15)
- Universal Height(Model Nos. beginning in 16 or 17)
- Hanging(Model Nos. beginning in 14)
- Worksurface Supporting** ... (Model Nos. beginning in 19 or 36)
- Under Worksurface Mobile ... (Model Nos. beginning in 18 or 33)

Worksurface height supporting pedestals have a taller base plate, resulting in a taller overall cabinet height. Consideration must be made to ensure that units align visually with each other. The accompanying chart will help you select the correct pedestal for your application.

Pedestal Models (Nos. begin with)	Style	Overall Height	Base Height	Spacer required below worksurface
15	Box/File mobile	22½"	N/A	N/A
16 or 17	Universal height	26¾"	2"	OPTIONAL
14	Hanging	19½"	N/A	N/A
19 or 36	Worksurface supporting**	28"	3½"	NO
18 or 33	Under Worksurface mobile	28"	3½"	NO

** Units will support conventional 29½"H worksurfaces, WITHOUT SPACERS.

 Shippable by small-package carrier.

SPECIFY: Model.Laminate or Paint (where applicable)
Model/Paint Grade "2".Paint

EXAMPLES: 21520TP.G1
11620PC.2.T1

Flush Kick Plates

GSA SIN 711-3

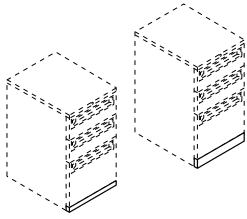

- ▶ **NEW!** Choice/Metallic and Custom paint options.
- ▶ See specifying information below for Choice/Metallic paint and pages 9 and 337 for Custom paint ordering instructions.
- ▶ Mounts to base of pedestal to provide a flush appearance to coordinate with laterals, file centers and storage towers.
- ▶ Kick plate is field-installable.
- ▶ Choose paint/color grades. See page 336 and 337 for paint options.
- ▶ Meets or exceeds ANSI/BIFMA and ISTA performance standards.

seating systems desks



storage & files

tables

education

accessories

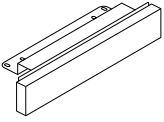
index

	Description	Model	Ship Weight	Cube	List by Paint Grade		
					Core	Choice/Metallics "2"	Custom "3"
	Flush Front Kick Plate for 28"H Pedestals	KP2800	3 	0.2	\$ 66	\$ 71	\$ 76

	Flush Front Kick Plate for 26 ⁷ / ₈ "H Pedestals	KP2678	3 	0.2	\$ 66	\$ 71	\$ 76
---	--	---------------	---	-----	-------	-------	-------

GSA — Above models receive Initiate Panel System discounting.

 Shippable by small-package carrier.

SPECIFY: Model.Paint
Model/Paint Grade "2". Paint

EXAMPLES: KP2800.P
KP28002.T1

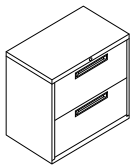

Flagship®

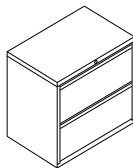

Model 872L

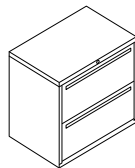

Model 772L

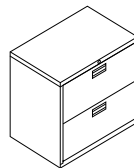

Model 672L

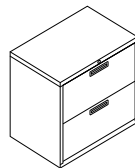

Model 572L

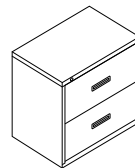

Model 432L

Flagship Series lateral files are 18"D.

800, 700, 600, 500 and 400 Series lateral files are all 19¼"D.

Series	Widths Available	Heights Available	Suspension Style	Usage	Pull	Safety Interlock	Lock	Features
Flagship** , 800, 700, 600	30" 36" 42"	2 dwr 3 dwr 4 dwr 5 dwr	Heavy Duty ball-bearing (telescoping)	Intensive	Flagship Series 4 Pulls available. See page 454. 800 Series Full-width radius designer style with magnetic label holders 700 Series Full-width designer style with magnetic label holders 600 Series Anodized Aluminum w/label holder	Positive Mechanical	Core removable	<ul style="list-style-type: none"> • 4 leveling glides • 2 hangrails per drawer • Rack resistant case reinforcement
500	30" 36"	2 dwr 4 dwr 5 dwr ^{††}	Ball-bearing	Moderate	Color-matched polymer	Positive Mechanical	Core removable	<ul style="list-style-type: none"> • 4 leveling glides • 2 hangrails per drawer
400	30" only	2 dwr* 4 dwr	Ball-bearing	Casual	Color-matched polymer (centered)	Positive Mechanical	Core removable	<ul style="list-style-type: none"> • 2 leveling glides • 2 hangrails per drawer

* Models feature standard counterweights where applicable to meet ANSI/BIFMA stability requirements.

** Flagship lateral files are not available with Binder Storage.

†† 500 Series 5 drawer model available in 36"W only.

All products meet or exceed ANSI/BIFMA and ISTA performance standards.

CONFIGURATION OPTIONS – LATERAL FILES				
A. Standard drawers	B. Receding door with roll-out shelf		Posting shelf	
Most popular. Holds: <ul style="list-style-type: none"> • Standing files • Hanging files • Letter, legal or A4 • Supplies Side-to-side standard, Front-to-back optional	More flexible. Holds: <ul style="list-style-type: none"> • End-tab files • Standing files • Hanging files • Letter, legal or A4 • Larger/boxed supplies Side-to-side standard, Front-to-back optional		Convenient for access, review and replacement of records; only available on select 5-high models.	
SERIES/SUFFIX: 400L Heights Offered: 2, 4	500L 2, 4, 5	Flagship 2, 3, 4, 5	600L, 700L, 800L 2, 3, 4, 5	NOTE: AB designated drawers are available either as all "A" or all "B" within a cabinet.
Widths Offered: 30"	30", 36"	30", 36", 42"	30", 36", 42"	

800 Series Lateral Files w/Drawers

GSA SIN 711-3

HON
Smart now. Smarter later.

- ▶ **NEW!** Choice/Metallic and Custom paint options.
- ▶ 30", 36" & 42" case widths with drawers, 19 1/4" case depth.
- ▶ Flush top and sides.
- ▶ Choose paint/color grades. See pages 336 and 337 for paint options.
- ▶ Counterweight included where applicable to meet ANSI/BIFMA stability requirements.
- ▶ Three-part, telescoping, steel ball bearing suspension.
- ▶ Features drawer extension restraint; mechanical interlock inhibits the extension of more than one drawer at a time.
- ▶ Four adjustable leveling glides.
- ▶ Lock mechanism secures both sides of drawer.
- ▶ Baked enamel finish over rust-inhibiting phosphate pre-treatment.
- ▶ Two adjustable hangrails per drawer for side-to-side filing.
- ▶ Optional laminate tops and accessories — see page 368.
- ▶ Reinforced case construction.
- ▶ Equipped with HON "One Key" interchangeable core removable locks. Keyed alike cores must be ordered separately — see page 463.
- ▶ Full-width radius designer style pull.
- ▶ Magnetic labels standard — one per drawer.
- ▶ Meets or exceeds ANSI/BIFMA and ISTA performance standards.



ONE KEY Refer to page 463



28 3/8"H

Description

Model

Ship Weight

Cube

List by Paint Grade

Choice/ Custom
Core Metallics "2" "3"

30"W 2 Drawer
36"W 2 Drawer
42"W 2 Drawer

IN STOCK

872L
882L
892L

118
129
144

12.4
14.8
17.1

\$ 607 \$ 637 \$ 667
\$ 679 \$ 709 \$ 739
\$ 784 \$ 814 \$ 844

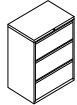

40 7/8"H

30"W 3 Drawer
36"W 3 Drawer
42"W 3 Drawer

IN STOCK

873L
883L
893L

160
165
176

17.2
20.6
23.8

\$ 862 \$ 892 \$ 922
\$ 963 \$ 993 \$ 1023
\$ 1118 \$ 1148 \$ 1178

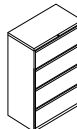

53 1/4"H

30"W 4 Drawer (with lock)
36"W 4 Drawer (with lock)
42"W 4 Drawer (with lock)

IN STOCK

874L
884L
894L

175
190
206

22.1
26.4
30.6

\$ 1047 \$ 1107 \$ 1167
\$ 1188 \$ 1248 \$ 1308
\$ 1364 \$ 1424 \$ 1484

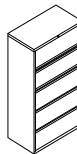

67"H

30"W 5 Drawer w/Posting Shelf
36"W 5 Drawer w/Posting Shelf
42"W 5 Drawer w/Posting Shelf

IN STOCK

875L
885L
895L

204
240
264

27.5
32.9
38.0

\$ 1393 \$ 1453 \$ 1513
\$ 1567 \$ 1627 \$ 1687
\$ 1811 \$ 1871 \$ 1931

NOTE: Top drawer is a roll-out shelf.

NOTE: See page 354 for Overfiles and page 368 for Lateral File Accessories.

SPECIFY: Model.Paint
Model/Paint Grade "2".Paint

EXAMPLE: 872L.P
872L2.T1

800 Series Lateral File w/Storage

GSA SIN 711-3

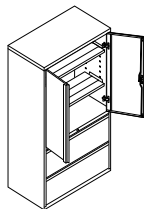

- ▶ **NEW!** Choice/Metallic and Custom paint options.
- ▶ 30", 36" & 42" case widths, 19 1/4" case depth.
- ▶ 67"H case — matches height of 800 Series 5 Drawer laterals.
- ▶ Bottom two openings are lateral drawers, remainder of case is storage shelves.
- ▶ Lateral file drawer features are same as 800 Series Laterals shown above.
- ▶ Inside dimension of storage case is 36 1/4"H. Includes 2 adjustable shelves, adjustable in 2" increments. Bottom shelves accept two rows of 3-ring binders; top opening measures: 10 1/4".
- ▶ Storage case is standard with 2 hinged doors. Door pulls match lateral file drawer pulls.
- ▶ Equipped with HON "One Key" interchangeable core removable locks. Locks on storage case and lateral file are keyed alike. Lateral file drawers lock independently from storage case.
- ▶ Four adjustable leveling glides.
- ▶ Magnetic labels supplied with unit (one per lateral file drawer).
- ▶ Meets or exceeds ANSI/BIFMA and ISTA performance standards.



ONE KEY Refer to page 463

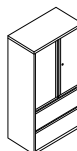

67"H

Description

Model

Ship Weight

Cube

List by Paint Grade

Choice/ Custom
Core Metallics "2" "3"

30"W 2 Drawer Lateral File w/Storage Case
36"W 2 Drawer Lateral File w/Storage Case
42"W 2 Drawer Lateral File w/Storage Case

875LS
885LS
895LS

174
210
228

27.5
32.9
38.0

\$ 1022 \$ 1082 \$ 1142
\$ 1128 \$ 1188 \$ 1248
\$ 1289 \$ 1349 \$ 1409

GSA — Above models receive Other Filing & Storage discounting.

NOTE: See page 368 for Lateral File Accessories and page 381 for Wire Dividers.

IN STOCK See page 1.

SPECIFY: Model.Paint
Model/Paint Grade "2".Paint

EXAMPLE: 875LS.P
875LS2.T1

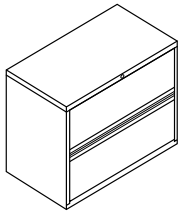

- ▶ **NEW!** Choice/Metallic and Custom paint options.
- ▶ 30", 36" & 42" case widths with rollout shelves, 19¼" case depth.
- ▶ Equipped with HON "One Key" interchangeable core removable locks. Keyed alike cores must be ordered separately — see page 463.
- ▶ Choose paint/color grades. See pages 336 and 337 for paint options.
- ▶ Counterweight included where applicable to meet ANSI/BIFMA stability requirements.
- ▶ Three-part, telescoping, slide suspension operates on steel ball bearings.
- ▶ Features drawer extension restraint; mechanical interlock inhibits the extension of more than one shelf at a time.
- ▶ Four adjustable leveling glides.
- ▶ Lock mechanism secures both sides of drawer.
- ▶ Baked enamel finish over rust-inhibiting phosphate pre-treatment.
- ▶ Two adjustable hangrails per opening for side-to-side filing.
- ▶ Optional laminate tops and accessories — see page 368.
- ▶ Full-width radius designer pull.
- ▶ Flush top and sides.
- ▶ Magnetic labels standard — one per opening.
- ▶ Fixed front bottom drawer on all roll-out shelf units (standard drawer).
- ▶ Meets or exceeds ANSI/BIFMA and ISTA performance standards.



ONE KEY Refer to page 463

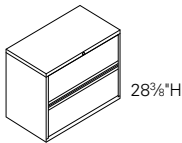

Description

30"W 2 Opening
36"W 2 Opening
42"W 2 Opening

Model

842L
852L
862L

Ship Weight

118
129
144

Cube

12.4
14.8
17.1

List by Paint Grade

Choice/ Custom
Core Metallics "2" "3"

\$ 761 \$ 791 \$ 821
\$ 842 \$ 872 \$ 902
\$ 973 \$1003 \$1033

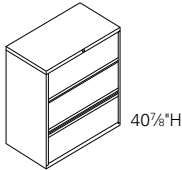

30"W 3 Opening
36"W 3 Opening
42"W 3 Opening

843L
853L
863L

160
165
176

17.2
20.6
23.8

\$ 999 \$1029 \$1059
\$1122 \$1152 \$1182
\$1294 \$1324 \$1354

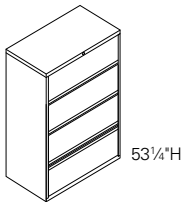

30"W 4 Opening
36"W 4 Opening
42"W 4 Opening

844L
854L
864L

175
190
206

22.1
26.4
30.6

\$1258 \$1318 \$1378
\$1424 \$1484 \$1544
\$1643 \$1703 \$1763

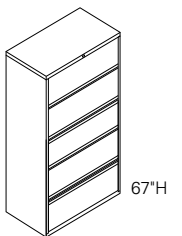

30"W 5 Opening w/Posting Shelf (w/lock)
36"W 5 Opening w/Posting Shelf (w/lock)
42"W 5 Opening w/Posting Shelf (w/lock)

845L
855L
865L

204
240
264

27.5
32.9
38.0

\$1638 \$1698 \$1758
\$1854 \$1914 \$1974
\$2135 \$2195 \$2255

NOTE: See page 354 for Overfiles and page 368 for Lateral File Accessories.

**SPECIFY: Model.Paint
Model/Paint Grade "2".Paint**

**EXAMPLES: 842L.P
842L2.T1**

700 Series Lateral Files w/Drawers

GSA SIN 711-3

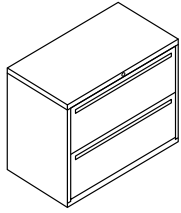

- ▶ **NEW!** Choice/Metallic and Custom paint options.
- ▶ 30", 36" & 42" case widths with drawers, 19¼" case depth.
- ▶ Choose paint/color grades. See pages 336 and 337 for paint options.
- ▶ Full-face integral drawer pulls.
- ▶ Counterweight included where applicable to meet ANSI/BIFMA stability requirements.
- ▶ Three-part, telescoping, steel ball bearing suspension.
- ▶ Features drawer extension restraint; mechanical interlock inhibits the extension of more than one drawer at a time.
- ▶ Four adjustable leveling glides.
- ▶ Lock mechanism secures both sides of drawer.
- ▶ Baked enamel finish over rust-inhibiting phosphate pre-treatment.
- ▶ Two adjustable hangrails per drawer/rollout shelf for side-to-side filing.
- ▶ Optional laminate tops and accessories — see page 368.
- ▶ Reinforced case construction.
- ▶ Flush top and sides.
- ▶ Magnetic labels supplied with unit (one per drawer).
- ▶ Equipped with HON "One Key" interchangeable core removable locks. Keyed alike cores must be ordered separately — see page 463.
- ▶ Meets or exceeds ANSI/BIFMA and ISTA performance standards.



ONE KEY Refer to page 463



28 3/8"H

Description

30"W 2 Drawer (with lock)
36"W 2 Drawer (with lock)
42"W 2 Drawer (with lock)

Model

772L
IN STOCK 782L
IN STOCK 792L

Ship Weight Cube

120 12.4
132 14.3
148 17.1

List by Paint Grade

Core	Choice/Custom	
	"2"	"3"
\$ 607	\$ 637	\$ 667
\$ 679	\$ 709	\$ 739
\$ 784	\$ 814	\$ 844

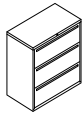

40 7/8"H

30"W 3 Drawer (with lock)
36"W 3 Drawer (with lock)
42"W 3 Drawer (with lock)

773L
IN STOCK 783L
IN STOCK 793L

163 17.2
169 20.6
182 23.8

\$ 862	\$ 892	\$ 922
\$ 963	\$ 993	\$1023
\$1118	\$1148	\$1178

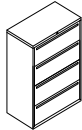

53 1/4"H

30"W 4 Drawer (with lock)
36"W 4 Drawer (with lock)
42"W 4 Drawer (with lock)

774L
IN STOCK 784L
IN STOCK 794L

179 22.1
196 26.4
214 30.6

\$1047	\$1107	\$1167
\$1188	\$1248	\$1308
\$1364	\$1424	\$1484

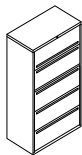

67"H

30"W 5 Drawer w/Posting Shelf (with lock)
36"W 5 Drawer w/Posting Shelf (with lock)
42"W 5 Drawer w/Posting Shelf (with lock)
NOTE: Top drawer is a roll-out shelf.

775L
IN STOCK 785L
IN STOCK 795L

209 27.5
247 32.9
274 38.0

\$1393	\$1453	\$1513
\$1567	\$1627	\$1687
\$1811	\$1871	\$1931

NOTE: See page 354 for Overfiles and page 368 for Lateral File Accessories.

SPECIFY: Model.Paint
Model/Paint Grade "2".Paint

EXAMPLE: 772L.P
775LS2.T1

700 Series Lateral Files w/Storage

GSA SIN 711-3

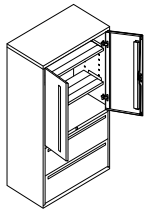

- ▶ **NEW!** Choice/Metallic and Custom paint options.
- ▶ 30", 36" & 42" case widths, 19¼" case depth.
- ▶ 67"H case — matches height of 700 Series 5 Drawer laterals.
- ▶ Bottom two openings are lateral drawers, remainder of case is storage shelves.
- ▶ Lateral file drawer features are same as 700 Series Laterals shown above.
- ▶ Inside dimension of storage case is 36¼"H. Includes 2 adjustable shelves, adjustable in 2" increments. Bottom shelves accept two rows of 3-ring binders; top opening measures: 10¼".
- ▶ Storage case is standard with 2 hinged doors. Door pulls match lateral file drawer pulls.
- ▶ Equipped with HON "One Key" interchangeable core removable locks. Locks on storage case and lateral file are keyed alike. Lateral file drawers lock independently from storage case.
- ▶ Four adjustable leveling glides.
- ▶ Magnetic labels supplied with unit (one per lateral file drawer).
- ▶ Meets or exceeds ANSI/BIFMA and ISTA performance standards.



ONE KEY Refer to page 463

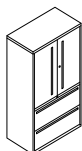

67"H

Description

30"W 2 Drawer Lateral File w/Storage Case
36"W 2 Drawer Lateral File w/Storage Case
42"W 2 Drawer Lateral File w/Storage Case

Model

775LS
785LS
795LS

Ship Weight Cube

175 27.5
211 32.9
230 38.0

List by Paint Grade

Core	Choice/Custom	
	"2"	"3"
\$1022	\$1082	\$1142
\$1128	\$1188	\$1248
\$1289	\$1349	\$1409

GSA — Above models receive Other Filing & Storage discounting.

NOTE: See page 368 for Lateral File Accessories and page 381 for Wire Dividers.

IN STOCK See page 1.

SPECIFY: Model.Paint
Model/Paint Grade "2".Paint

EXAMPLE: 775LS.P
775LS2.T1

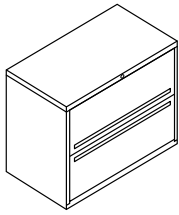

- ▶ **NEW!** Choice/Metallic and Custom paint options.
- ▶ 30", 36" & 42" case widths with roll-out shelves, 19¼" case depth.
- ▶ Choose paint/color grades. See pages 336 and 337 for paint options.
- ▶ Counterweight included where applicable to meet ANSI/BIFMA stability requirements.
- ▶ Three-part, telescoping, steel ball bearing suspension.
- ▶ Features shelf extension restraint; mechanical interlock inhibits the extension of more than one shelf at a time.
- ▶ Four adjustable leveling glides.
- ▶ Lock mechanism secures both sides of drawer.
- ▶ Full-face integral drawer pulls.
- ▶ Flush top and sides.
- ▶ Baked enamel finish over rust-inhibiting phosphate pre-treatment.
- ▶ Two adjustable hangrails per drawer/rollout shelf for side-to-side filing.
- ▶ Optional laminate tops and accessories — see page 368.
- ▶ Reinforced case construction.
- ▶ Equipped with HON "One Key" interchangeable core removable locks. Keyed alike cores must be ordered separately — see page 463.
- ▶ Magnetic labels supplied with unit (one per opening).
- ▶ Fixed bottom drawer on all roll-out shelf units (standard drawer).
- ▶ Meets or exceeds ANSI/BIFMA and ISTA performance standards.



ONE KEY Refer to page 463

	Description	Model	Ship Weight	Cube	List by Paint Grade		
					Core	Choice/Metallics "2"	Custom "3"
 28¾"H	30"W 2 Opening	742L	120	12.4	\$ 761	\$ 791	\$ 821
	36"W 2 Opening	752L	132	14.8	\$ 842	\$ 872	\$ 902
	42"W 2 Opening	762L	148	17.1	\$ 973	\$1003	\$1033
 40¾"H	30"W 3 Opening	743L	163	17.2	\$ 999	\$1029	\$1059
	36"W 3 Opening	753L	169	20.6	\$1122	\$1152	\$1182
	42"W 3 Opening	763L	182	23.8	\$1294	\$1324	\$1354
 53¼"H	30"W 4 Opening	744L	179	22.1	\$1258	\$1318	\$1378
	36"W 4 Opening	754L	196	26.4	\$1424	\$1484	\$1544
	42"W 4 Opening	764L	214	30.6	\$1643	\$1703	\$1763
 67"H	30"W 5 Opening w/Posting Shelf	745L	209	27.5	\$1638	\$1698	\$1758
	36"W 5 Opening w/Posting Shelf	755L	247	32.9	\$1854	\$1914	\$1974
	42"W 5 Opening w/Posting Shelf	765L	274	38.0	\$2135	\$2195	\$2255

NOTE: See page 354 for Overfiles and page 368 for Lateral File Accessories.

**SPECIFY: Model.Paint
Model/Paint Grade "2".Paint**

**EXAMPLE: 742L.P
742L2.T1**

600 Series Lateral Files w/Drawers

GSA SIN 711-3

HON
Smart now. Smarter later.

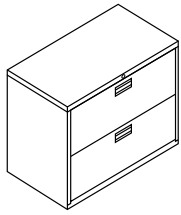

- ▶ **NEW!** Choice/Metallic and Custom paint options.
- ▶ 30", 36" & 42" case widths with drawers, 19¼" case depth.
- ▶ Choose paint/color grades. See pages 336 and 337 for paint options.
- ▶ Counterweight included where applicable to meet ANSI/BIFMA stability requirements.
- ▶ Three-part, telescoping, steel ball-bearing suspension.
- ▶ Features drawer extension restraint; mechanical interlock inhibits the extension of more than one drawer at a time.
- ▶ Four adjustable leveling glides.
- ▶ Lock mechanism secures both sides of drawer.
- ▶ Flush top and sides.
- ▶ Baked enamel finish over rust-inhibiting phosphate pre-treatment.
- ▶ Two adjustable hangrails per drawer/roll-out shelf for side-to-side filing.
- ▶ Optional laminate tops and accessories — see page 368.
- ▶ Equipped with HON "One Key" interchangeable core removable locks. Keyed alike cores must be ordered separately — see page 463.
- ▶ Reinforced case construction.
- ▶ Bright anodized aluminum recessed drawer pull/plastic label holder.
- ▶ Meets or exceeds ANSI/BIFMA and ISTA performance standards.



ONE KEY Refer to page 463

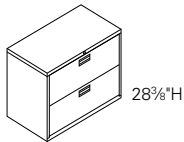

Description

Model

Ship Weight Cube

List by Paint Grade
Choice/ Custom
Core Metallics "2" "3"

30"W 2 Drawer
36"W 2 Drawer
42"W 2 Drawer

IN STOCK 672L
IN STOCK 682L
IN STOCK 692L

120 12.4
132 14.3
148 17.1

\$ 578 \$ 608 \$ 638
\$ 622 \$ 652 \$ 682
\$ 735 \$ 765 \$ 795

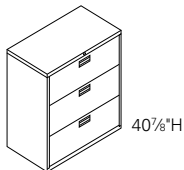

30"W 3 Drawer
36"W 3 Drawer
42"W 3 Drawer

IN STOCK 673L
IN STOCK 683L
IN STOCK 693L

163 17.2
169 20.6
182 23.8

\$ 796 \$ 826 \$ 856
\$ 872 \$ 902 \$ 932
\$1025 \$1055 \$1085

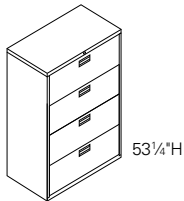

30"W 4 Drawer
36"W 4 Drawer
42"W 4 Drawer

IN STOCK 674L
IN STOCK 684L
IN STOCK 694L

179 22.1
196 26.4
214 30.6

\$ 990 \$1050 \$1110
\$1082 \$1142 \$1202
\$1285 \$1345 \$1405

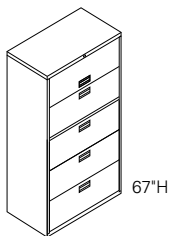

30"W 5 Drawer w/Posting Shelf
36"W 5 Drawer w/Posting Shelf
42"W 5 Drawer w/Posting Shelf

IN STOCK 675L
IN STOCK 685L
IN STOCK 695L

209 27.5
247 32.9
274 38.0

\$1317 \$1377 \$1437
\$1408 \$1468 \$1528
\$1700 \$1760 \$1820

NOTE: Top drawer is a roll-out shelf.

NOTE: See page 354 for Overfiles and page 368 for Lateral File Accessories.

IN STOCK See page 1.

SPECIFY: Model.Paint
Model/Paint Grade "2".Paint

EXAMPLES: 672L.P
672L2.T1

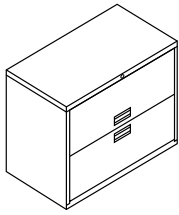

- ▶ **NEW!** Choice/Metallic and Custom paint options.
- ▶ 30", 36" & 42" case widths with roll-out shelves, 19¼" case depth.
- ▶ Choose paint/color grades. See pages 336 and 337 for paint options.
- ▶ Counterweight included where applicable to meet ANSI/BIFMA stability requirements.
- ▶ Three-part, telescoping, steel ball-bearing suspension.
- ▶ Features drawer extension restraint; mechanical interlock inhibits the extension of more than one shelf at a time.
- ▶ Four adjustable leveling glides.
- ▶ Lock mechanism secures both sides of drawer.
- ▶ Flush top and sides.
- ▶ Baked enamel finish over rust-inhibiting phosphate pre-treatment.
- ▶ Two adjustable hangrails per opening for side-to-side filing.
- ▶ Optional laminate tops and accessories — see page 368.
- ▶ Reinforced case construction.
- ▶ Equipped with HON "One Key" interchangeable core removable locks. Keyed alike cores must be ordered separately — see page 463.
- ▶ Bright anodized aluminum recessed drawer pull/plastic label holder.
- ▶ Fixed bottom drawer on all roll-out shelf units (standard drawer).
- ▶ Meets or exceeds ANSI/BIFMA and ISTA performance standards.



ONE KEY Refer to page 463

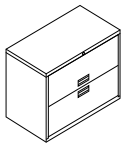

28 3/8"H

Description

30"W 2 Opening
36"W 2 Opening
42"W 2 Opening

NOTE: Bottom opening is a fixed front drawer.

Model

642L
652L
662L

Ship Weight **Cube**

120 12.4
132 14.8
148 17.1

List by Paint Grade

Choice/ **Custom**
Core **Metallics "2"** **"3"**

\$ 742 \$ 772 \$ 802
\$ 821 \$ 851 \$ 881
\$ 945 \$ 975 \$ 1005



40 7/8"H

30"W 3 Opening
36"W 3 Opening
42"W 3 Opening

NOTE: Bottom opening is a fixed front drawer.

643L
653L
663L

163 17.2
169 20.6
182 23.8

\$ 969 \$ 999 \$ 1029
\$ 1089 \$ 1119 \$ 1149
\$ 1246 \$ 1276 \$ 1306



53 1/4"H

30"W 4 Opening
36"W 4 Opening
42"W 4 Opening

NOTE: Bottom opening is a fixed front drawer.

644L
654L
664L

179 22.1
196 26.4
214 30.6

\$ 1213 \$ 1273 \$ 1333
\$ 1373 \$ 1433 \$ 1493
\$ 1574 \$ 1634 \$ 1694

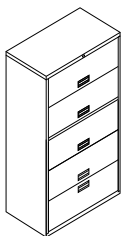

67"H

30"W 5 Opening w/Posting Shelf
36"W 5 Opening w/Posting Shelf
42"W 5 Opening w/Posting Shelf

NOTE: Bottom opening is a fixed front drawer.

645L
655L
665L

209 27.5
247 32.9
274 38.0

\$ 1574 \$ 1634 \$ 1694
\$ 1777 \$ 1837 \$ 1897
\$ 2046 \$ 2106 \$ 2166

NOTE: See page 354 for Overfiles and page 368 for Lateral File Accessories.

SPECIFY: Model.Paint
Model/Paint Grade "2".Paint

EXAMPLE: 642L.P
642L2.T1

500 Series Lateral Files

GSA SIN 711-3

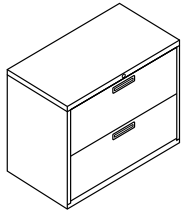

- ▶ 30" & 36" case widths with drawers, 19¼" case depth.
- ▶ Counterweight included where applicable to meet ANSI/BIFMA stability requirements.
- ▶ Equipped with HON "One Key" interchangeable core removable locks. Keyed alike cores must be ordered separately — see page 463.
- ▶ Ball bearing slide suspension.
- ▶ Two adjustable hangrails per drawer/roll-out shelf for side-to-side filing.
- ▶ Four adjustable leveling glides.
- ▶ Features drawer extension restraint; mechanical interlock inhibits the extension of more than one drawer at a time.
- ▶ Lock mechanism secures both sides of drawer.
- ▶ Baked enamel finish over rust-inhibiting phosphate pre-treatment.
- ▶ Monochromatic drawer pull.
- ▶ Reinforced case construction.
- ▶ Flush top and sides.
- ▶ Magnetic label holder.
- ▶ Optional laminate tops and accessories — see page 368.
- ▶ Meets or exceeds ANSI/BIFMA and ISTA performance standards.



ONE KEY Refer to page 463

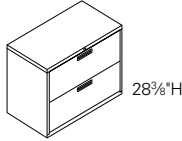

Description	Model	Ship Weight	Cube	List Core
30"W 2 Drawer	572L	112	12.4	\$ 532
36"W 2 Drawer	IN STOCK 582L	128	14.8	\$ 582



30"W 4 Drawer	574L	148	22.1	\$ 893
36"W 4 Drawer	IN STOCK 584L	177	26.4	\$ 997

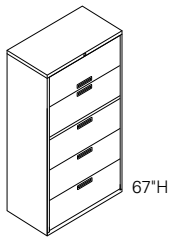

36"W 5 Drawer	IN STOCK 585L	229	32.9	\$1293
---------------	----------------------	-----	------	--------

NOTE: Top drawer is a roll-out shelf.

NOTE: See page 354 for Overfiles and page 368 for Lateral File Accessories.

IN STOCK See page 1.

SPECIFY: Model.Paint

EXAMPLE: 572L.P

index accessories education tables storage & files seating systems desking

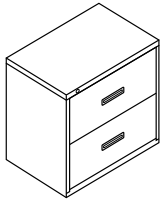

- ▶ 30" case width, 19¼" case depth.
- ▶ Counterweight included where applicable to meet ANSI/BIFMA stability requirements.
- ▶ Equipped with HON "One Key" interchangeable core removable locks. Keyed alike cores must be ordered separately — see page 463.
- ▶ Ball bearing slide suspension.
- ▶ Two adjustable leveling glides in front corners.
- ▶ Features drawer extension restraint; mechanical interlock inhibits the extension of more than one drawer at a time.
- ▶ Two adjustable hangrails provided, per drawer, for side-to-side filing.
- ▶ Reinforced case construction.
- ▶ Baked enamel finish over rust-inhibiting phosphate pre-treatment.
- ▶ Monochromatic drawer pulls.
- ▶ Optional laminate tops and accessories — see page 368.
- ▶ Meets or exceeds ANSI/BIFMA and ISTA performance standards.



ONE KEY Refer to page 463



28¾"H

NOC

Description	Model	Ship Weight	Cube	List Core
30"W 2 Drawer	IN stock 432L	110	12.4	\$ 483



53¼"H

NOC

30"W 4 Drawer	IN stock 434L	145	22.1	\$ 657
---------------	----------------------	-----	------	--------

NOTE: See page 354 for Overfiles and page 368 for Lateral File Accessories.

IN stock See page 1.

SPECIFY: Model.Paint

EXAMPLE: 432L.P

Lateral File Accessories

GSA SIN 711-3

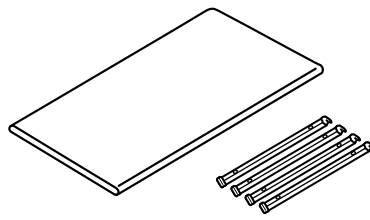

▶ Laminate tops are abrasion-resistant, high-pressure laminate.

▶ Hanging file racks, dividers and extended hangrails available in Gray only.
▶ Compatible with Flagship®, 800, 700, 600, 500, and 400 Series Lateral Files.

▶ Meets or exceeds applicable ANSI/BIFMA and ISTA performance standards.

index accessories education tables storage & files seating systems desking

	Description	Model	Ship Weight	Cube	List
	30"W x 19¼"D x 1½" Thick Radius Edge Laminate Top	518330	20	2.1	\$ 260
	36"W x 19¼"D x 1½" Thick Radius Edge Laminate Top	518336	25	2.5	\$ 287
	42"W x 19¼"D x 1½" Thick Radius Edge Laminate Top	518342	30	2.9	\$ 330
	60"W x 19¼"D x 1½" Thick Radius Edge Laminate Top	518360	64	3.9	\$ 431
	72"W x 19¼"D x 1½" Thick Radius Edge Laminate Top	518372	75	5.0	\$ 479
	NOTE: Compatible with 800, 700, 600, 500, and 400 Series Lateral Files.				
	30"W x 19¼"D x 1½" Thick Square Edge Laminate Top	519489	20	2.1	\$ 247
	36"W x 19¼"D x 1½" Thick Square Edge Laminate Top	519480	25	2.5	\$ 272
	42"W x 19¼"D x 1½" Thick Square Edge Laminate Top	519481	30	2.9	\$ 309
	60"W x 19¼"D x 1½" Thick Square Edge Laminate Top	519490	32	3.9	\$ 410
	72"W x 19¼"D x 1½" Thick Square Edge Laminate Top	519482	40	5.0	\$ 450
	84"W x 19¼"D x 1½" Thick Square Edge Laminate Top	519483	48	6.1	\$ 494
NOTE: Compatible with 800, 700, 600, 500, and 400 Series Lateral Files.					
	30"W x 18"D x 1½" Thick Radius Edge Laminate Top	918530	20	1.6	\$ 251
	36"W x 18"D x 1½" Thick Radius Edge Laminate Top	918536	25	1.8	\$ 309
	42"W x 18"D x 1½" Thick Radius Edge Laminate Top	918542	30	2.1	\$ 348
	60"W x 18"D x 1½" Thick Radius Edge Laminate Top	918560	32	3.0	\$ 434
	66"W x 18"D x 1½" Thick Radius Edge Laminate Top	918566	40	3.2	\$ 475
	72"W x 18"D x 1½" Thick Radius Edge Laminate Top	918572	48	3.5	\$ 514
NOTE: Compatible with Flagship® 18"D Lateral Files only.					
	30"W x 18"D x 1½" Thick Square Edge Laminate Top	919430	20	1.6	\$ 238
	36"W x 18"D x 1½" Thick Square Edge Laminate Top	919436	25	1.8	\$ 297
	42"W x 18"D x 1½" Thick Square Edge Laminate Top	919442	30	2.1	\$ 326
	60"W x 18"D x 1½" Thick Square Edge Laminate Top	919460	32	3.0	\$ 414
	66"W x 18"D x 1½" Thick Square Edge Laminate Top	919466	40	3.2	\$ 475
	72"W x 18"D x 1½" Thick Square Edge Laminate Top	919472	48	3.5	\$ 485
NOTE: Compatible with Flagship® 18"D Lateral Files only.					
	Single Rail Hanging File Racks (4/pack) (For front-to-back filing — 30"W, 36"W and 42"W files) Order one package per drawer for 42"W files. One package will do two 30"W or 36"W file drawers. Gray only. Racks span between 15¼"W rails.	919491	1.0	0.4	\$ 35
	Double-Rail Hanging File Racks (2/pack) (For 3 rows front-to-back — 42"W files) Order one package per drawer. Gray only. Racks span between 15¼"W rails.	919492	1.5	0.4	\$ 35
	Dividers 7½"H x 15"D (10/pack). Gray only.	515704	12	0.5	\$ 91
	Extended Hangrails — 4¼"H (5/pack). Gray only. (Installs over side-to-side hangrail to create a full height back) For 30"W Lateral Files For 36"W Lateral Files For 42"W Lateral Files	919530 919536 919542	9 11 13	0.2 0.3 0.3	\$ 109 \$ 109 \$ 109

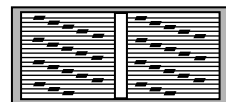

Front-to-back filing:

30" wide files *: 30½" of filing with letter/letter rows.

36" wide files *: 30½" of filing with letter/letter, legal/legal, or letter/legal rows.

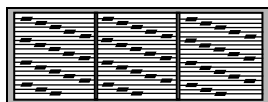

42" wide files **: 45¾" of filing with 3 rows letter or 30½" of 2 rows legal, or 2 standard printout rows.

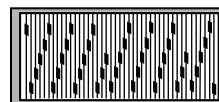

Side-to-side filing:

30" wide files: 27" of filing with letter or legal.

36" wide files: 33" of filing with letter or legal.

42" wide files: 39" of filing with letter or legal.

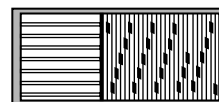

Combination filing:

(front-to-back with side-to-side in one drawer)

30" wide files: not recommended.

36" wide files*: 15¼" of front-to-back letter filing and 20¼" of side-to-side legal filing.

42" wide files*: 15¼" of front-to-back letter filing and 26¼" of side-to-side legal filing.

* Requires 919491 optional hangrails.

** Requires 919492 optional hangrails.

See page 1.

Shippable by small-package carrier.

SPECIFY: Model.Laminate or Model

EXAMPLE: 518330.N or 919491

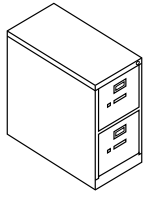

Model 252PB

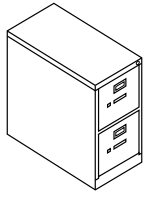

Model 212P

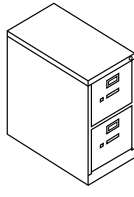

Model 312P

Vertical files listed below meets or exceeds ANSI/BIFMA and ISTA performance standards. They are available in 15"W letter and 18¼"W legal widths.

Series	Depth	Heights Available	Suspension Style	Lock	Accepts Hanging Files	Features
250B Series	28½"	2 dwr 4 dwr 5 dwr	Three-part telescoping, ball-bearing steel suspension	INCLUDED core removable	YES (Hangrails not required)	Spring-loaded follower block Fully enclosed security base
210 Series	28½"	2 dwr 4 dwr 5 dwr	Three-part telescoping, ball-bearing steel suspension	INCLUDED core removable	YES (Hangrails not required)	Spring-loaded follower block
310 Series	26½"	2 dwr 4 dwr 5 dwr	Three-part telescoping, ball-bearing steel suspension	INCLUDED core removable	YES (Hangrails not required)	Spring-loaded follower block

index accessories education tables storage & files seating systems desking

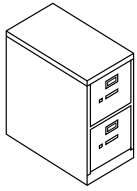

Model H322

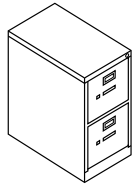

Model 512P

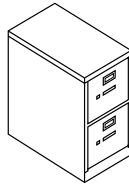

Model 532

Vertical files listed below meets or exceeds ANSI/BIFMA and ISTA performance standards.

Series	Depth	Heights Available	Suspension Style	Lock	Accepts Hanging Files	Features
H320 Series	26½"	2 dwr 4 dwr	Triple-tied cradle w/10 nylon rollers per drawer	OPTIONAL core removable	YES (Hangrails not required)	Spring-loaded follower block
510 Series	25"	2 dwr 4 dwr	Triple-tied cradle w/10 nylon rollers per drawer	INCLUDED core removable	YES (Hangrails not required)	Spring-loaded follower block
530 Series	25"	2 dwr 4 dwr	Triple-tied cradle w/10 nylon rollers per drawer	OPTIONAL core removable	YES (Hangrails not required)	Spring-loaded follower block

250B Series Vertical Files

GSA SIN 711-3

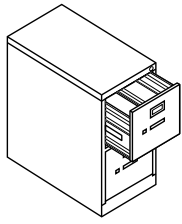

- ▶ **NEW!** Choice/Metallic and Custom paint options.
- ▶ See specifying information below for Choice/Metallic paint and pages 9 and 337 for Custom paint ordering instructions.
- ▶ High capacity file, 28½" Case depth with 27 front-to-back filing inches per drawer.
- ▶ Letter or legal sizes available.
- ▶ High drawer sides eliminates need for hangrails.
- ▶ Three-part telescoping, ball-bearing suspension.
- ▶ **Fully enclosed security base.**
- ▶ Aluminum drawer pulls, label holders and thumb latch.
- ▶ Standard interchangeable core removable locks. Equipped with HON "One Key" system. Keyed alike cores must be ordered separately — see page 463.
- ▶ Choose paint/color grades. See pages 336 and 337 for paint options.
- ▶ **Spring loaded follower block** with positive side-action positioning, is adjustable on ⅝" centers.
- ▶ Baked enamel finish over rust-inhibiting phosphate pre-treatment.
- ▶ Models meet or exceed ANSI/BIFMA and ISTA performance standards.



ONE KEY Refer to page 463

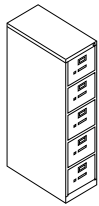
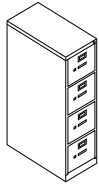
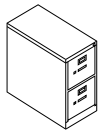

Description	Model	Ship Weight	Cube	List by Paint Grade		
				Core	Choice/Metallics "2"	Custom "3"
2 Drawer, Letter 29"H x 15"W x 28½"D	252PB		9.2	\$ 586	\$ 611	\$ 636
2 Drawer, Legal 29"H x 18¼"W x 28½"D	252CPB		10.0	\$ 660	\$ 685	\$ 710
4 Drawer, Letter 52"H x 15"W x 28½"D	254PB		16.5	\$ 797	\$ 837	\$ 877
4 Drawer, Legal 52"H x 18¼"W x 28½"D	254CPB		19.7	\$ 890	\$ 930	\$ 970
5 Drawer, Letter 60"H x 15"W x 28½"D	255PB		19.0	\$1048	\$1088	\$1128
5 Drawer, Legal 60"H x 18¼"W x 28½"D	255CPB		22.6	\$1164	\$1204	\$1244

NOTE: See page 378 for Vertical File Accessories.

**SPECIFY: Model.Paint
Model/Paint Grade "2".Paint**

**EXAMPLE: 252PB.P
252PB2.T1**

index accessories education tables storage & files seating systems desking

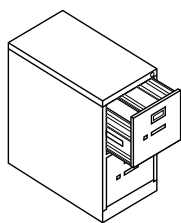

- ▶ **NEW!** Choice/Metallic and Custom paint options.
- ▶ See specifying information below for Choice/Metallic paint and pages 9 and 337 for Custom paint ordering instructions.
- ▶ High capacity file, 28½" Case depth with 27 front-to-back filing inches per drawer.
- ▶ Letter or legal sizes available.
- ▶ Three-part telescoping, steel ball-bearing suspension.
- ▶ Bright aluminum drawer pulls, label holders and thumb latch.
- ▶ Choose paint/color grades. See pages 336 and 337 for paint options.
- ▶ **Standard** interchangeable core removable locks. Equipped with HON "One Key" system. Keyed alike cores must be ordered separately — see page 463.
- ▶ **Accepts hanging files.** High drawer sides hold hanging file folders without use of hangrails.
- ▶ **Spring loaded follower block** with positive side-action positioning, is adjustable on ½" centers.
- ▶ Baked enamel finish over rust-inhibiting phosphate pre-treatment.
- ▶ Models meet or exceed ANSI/BIFMA and ISTA performance standards.



ONE KEY Refer to page 463

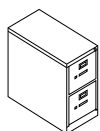

Description	Model	Ship Weight	Cube	List by Paint Grade		
				Core	Choice/Metallics "2"	Custom "3"
2 Drawer, Letter 29"H x 15"W x 28½"D	IN STOCK 212P	65	9.2	\$ 514	\$ 539	\$ 564
2 Drawer, Legal 29"H x 18¼"W x 28½"D	IN STOCK 212CP	71	11.0	\$ 587	\$ 612	\$ 637

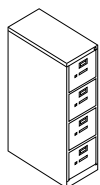

4 Drawer, Letter 52"H x 15"W x 28½"D	IN STOCK 214P	114	16.1	\$ 668	\$ 708	\$ 748
4 Drawer, Legal 52"H x 18¼"W x 28½"D	IN STOCK 214CP	123	19.2	\$ 748	\$ 788	\$ 828

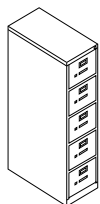

5 Drawer, Letter 60"H x 15"W x 28½"D	IN STOCK 215P	136	18.5	\$ 896	\$ 936	\$ 976
5 Drawer, Legal 60"H x 18¼"W x 28½"D	IN STOCK 215CP	145	22.1	\$1000	\$1040	\$1080

NOTE: See page 378 for Vertical File Accessories.

IN STOCK See page 1.
S Shippable by small-package carrier.

SPECIFY: Model.Paint
Model/Paint Grade "2".Paint

EXAMPLE: 212PP
212P2.T1

310 Series Vertical Files

GSA SIN 711-3

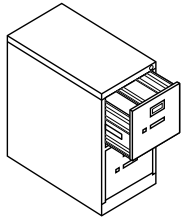

- ▶ **NEW!** Choice/Metallic and Custom paint options.
- ▶ See specifying information below for Choice/Metallic paint and pages 9 and 337 for Custom paint ordering instructions.
- ▶ 26½" Case depth with 25 front-to-back filing inches per drawer.
- ▶ Letter or legal sizes available.
- ▶ Three-part telescoping, steel ball-bearing suspension.
- ▶ Choose paint/color grades. See pages 336 and 337 for paint options.
- ▶ Bright aluminum drawer pulls, label holders and thumb latch.
- ▶ **Standard** interchangeable core removable locks. Equipped with HON "One Key" system. Keyed alike cores must be ordered separately — see page 463.
- ▶ **Accepts hanging files.** High drawer sides hold hanging file folders without use of hangrails.
- ▶ **Spring loaded follower block** with positive side-action positioning, is adjustable on 5/8" centers.
- ▶ Baked enamel finish over rust-inhibiting phosphate pre-treatment.
- ▶ Models meet or exceed ANSI/BIFMA and ISTA performance standards.



ONE KEY Refer to page 463

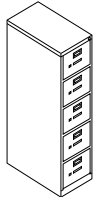
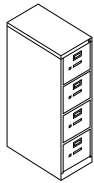

Description	Model	Ship Weight	Cube	List by Paint Grade		
				Choice/ Core	Metallics "2"	Custom "3"
2 Drawer, Letter (with lock) 29"H x 15"W x 26½"D	IN STOCK 312P	60	8.6	\$ 319	\$ 344	\$ 369
2 Drawer, Legal (with lock) 29"H x 18¼"W x 26½"D	IN STOCK 312CP	66	10.2	\$ 380	\$ 405	\$ 430
4 Drawer, Letter (with lock) 52"H x 15"W x 26½"D	IN STOCK 314P	107	15.0	\$ 435	\$ 475	\$ 515
4 Drawer, Legal (with lock) 52"H x 18¼"W x 26½"D	IN STOCK 314CP	116	18.0	\$ 499	\$ 539	\$ 579
5 Drawer, Letter (with lock) 60"H x 15"W x 26½"D	IN STOCK 315P	128	17.3	\$ 640	\$ 680	\$ 720
5 Drawer, Legal (with lock) 60"H x 18¼"W x 26½"D	IN STOCK 315CP	137	21.0	\$ 717	\$ 757	\$ 797

NOTE: See page 378 for Vertical File Accessories.

IN STOCK See page 1.
 Shippable by small-package carrier.

SPECIFY: Model.Paint
Model/Paint Grade "2".Paint

EXAMPLES: 312PP
312P2.T1

deskings systems seating storage & files tables education accessories index

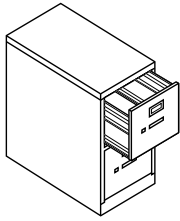

- ▶ **NEW!** Choice/Metallic and Custom paint options.
- ▶ Triple tied, full cradle drawer suspension.
- ▶ **Accepts hanging files.** High drawer sides hold hanging file folders without use of hangrails.
- ▶ See specifying information below for Choice/Metallic paint and pages 9 and 337 for Custom paint ordering instructions.
- ▶ 10 Nylon Rollers per drawer.
- ▶ **Spring loaded follower block** with positive side-action positioning, is adjustable on 5/8" centers.
- ▶ High capacity file, 26½" Case depth with 25 front-to-back filing inches per drawer.
- ▶ Bright aluminum drawer pulls, label holders and thumb latch.
- ▶ Baked enamel finish over rust-inhibiting phosphate pre-treatment.
- ▶ Letter or legal sizes available.
- ▶ Optional HON "One Key" interchangeable core removable lock.
- ▶ Choose paint/color grades. See pages 336 and 337 for paint options.



ONE KEY Refer to page 463



Description

Model

Ship Weight

Cube

List by Paint Grade

Core Choice/Metallics "2" Custom "3"

2 Drawer Letter, 29"H x 15"W x 26½"D
2 Drawer Legal, 29"H x 18¼"W x 26½"D

IN STOCK H322
IN STOCK H322C

60 8.6
66 10.2

\$ 290 \$ 315 \$ 340
\$ 348 \$ 373 \$ 398

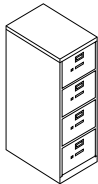

4 Drawer Letter, 52"H x 15"W x 26½"D
4 Drawer Legal, 52"H x 18¼"W x 26½"D

IN STOCK H324
IN STOCK H324C

106 15.0
116 18.0

\$ 403 \$ 443 \$ 483
\$ 464 \$ 504 \$ 544

NOTE: See page 378 for Vertical File Accessories.

IN STOCK See page 1.
S Shippable by small-package carrier.

**SPECIFY: Model.Paint
Model/Paint Grade "2".Paint**

**EXAMPLE: H322.P
H3222.T1**

510 Series Vertical Files

GSA SIN 711-3

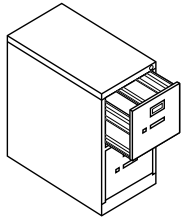

- ▶ **NEW!** Choice/Metallic and Custom paint options.
- ▶ See specifying information below for Choice/Metallic paint and pages 9 and 337 for Custom paint ordering instructions.
- ▶ 25" Case depth with 23½" front-to-back filing inches per drawer.
- ▶ Letter or legal sizes available.
- ▶ Triple tied, full cradle drawer suspension.
- ▶ 10 Nylon Rollers per drawer.
- ▶ Bright aluminum drawer pulls, label holders and thumb latch.
- ▶ **Standard** interchangeable core removable locks. Equipped with HON "One Key" system.
- ▶ Choose paint/color grades. See pages 336 and 337 for paint options.
- ▶ **Accepts hanging files.** High drawer sides hold hanging file folders without use of hangrails.
- ▶ **Spring loaded follower block** with positive side-action positioning, is adjustable on ½" centers.
- ▶ Baked enamel finish over rust-inhibiting phosphate pre-treatment.
- ▶ Models meet or exceed ANSI/BIFMA and ISTA performance standards.



ONE KEY Refer to page 463

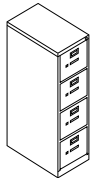

Description	Model	Ship Weight	Cube	List by Paint Grade		
				Core	Choice/Metallics "2"	Custom "3"
2 Drawer, Letter (with lock) 29"H x 15"W x 25"D	512P	58	8.0	\$ 277	\$ 302	\$ 327
2 Drawer, Legal (with lock) 29"H x 18¼"W x 25"D	512CP	63	9.7	\$ 331	\$ 356	\$ 381
4 Drawer, Letter (with lock) 52"H x 15"W x 25"D	514P	102	14.3	\$ 374	\$ 414	\$ 454
4 Drawer, Legal (with lock) 52"H x 18¼"W x 25"D	514CP	112	17.0	\$ 433	\$ 473	\$ 513

NOTE: See page 378 for Vertical File Accessories.

See page 1.
 Shippable by small-package carrier.

**SPECIFY: Model.Paint
 Model/Paint Grade "2".Paint**

**EXAMPLES: 512PP
 512P2.T1**

desk systems seating storage & files tables education accessories index

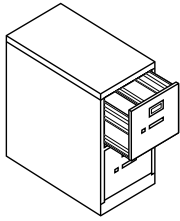

- ▶ **NEW!** Choice/Metallic and Custom paint options.
- ▶ See specifying information below for Choice/Metallic paint and pages 9 and 337 for Custom paint ordering instructions.
- ▶ Standard drawer sides.
- ▶ 25" Case depth with 23½" front-to-back filing inches per drawer.
- ▶ Letter or legal sizes available.
- ▶ Triple tied, full cradle drawer suspension.
- ▶ 10 Nylon Rollers per drawer.
- ▶ Bright aluminum drawer pulls, label holders and thumb latch.
- ▶ Optional HON "One Key" interchangeable core removable lock.
- ▶ Choose paint/color grades. See pages 336 and 337 for paint options.
- ▶ **Accepts hanging files.** High drawer sides hold hanging file folders without use of hangrails.
- ▶ **Spring loaded follower block** with positive side-action positioning, is adjustable on 5/8" centers.
- ▶ Baked enamel finish over rust-inhibiting phosphate pre-treatment.
- ▶ Models meet or exceed ANSI/BIFMA and ISTA performance standards.



ONE KEY Refer to page 463

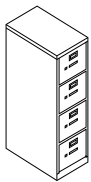









Description	Model	Ship Weight	Cube	List by Paint Grade		
				Core	Choice/Metallics "2"	Custom "3"
2-drawer letter, 29"H x 15"W x 25"D	IN STOCK 532	55	8.1	\$ 242	\$ 267	\$ 292
2-drawer legal, 29"H x 18¼"W x 25"D	532C	60	9.7	\$ 305	\$ 330	\$ 355
4-drawer letter, 52"H x 15"W x 25"D	IN STOCK 534	97	14.3	\$ 335	\$ 375	\$ 415
4-drawer legal, 52"H x 18¼"W x 25"D	534C	106	17.0	\$ 407	\$ 447	\$ 487

NOTE: See page 378 for Vertical File Accessories.

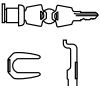
IN STOCK See page 1.
S Shippable by small-package carrier.

SPECIFY: Model.Paint
Model/Paint Grade "2".Paint

EXAMPLE: 532.P
5322.T1

	Description	Model	Ship Weight	Cube	List
	Follower Block, Legal (4/pack)	F60	8.0 	0.6	\$ 56
	Follower Block, Letter (4/pack)	F50	7.0 	0.5	\$ 53
SIN 711-3					
 <i>Lock info page 463.</i>	Chrome Core Removable Lock Kit (Field installable) Specify key number from 101E-225E. Lock info page 463.	 F24	0.2 	0.2	\$ 31
	Bulk Package — 25 F24 Lock Kits (Individually shrink wrapped)	F2425	6.3 	0.5	\$ 661
	Bulk Package — 50 F24 Lock Kits (Individually shrink wrapped)	F2450	12.5 	0.9	\$1240
	Bulk Package — 50 F24 Lock Kits (Component parts in bag) NOTE: Bulk Package key numbers are at random and can not be specified.	F2451	12.5 	0.9	\$1027

NOC

GSA — Above models receive Vertical, Lateral & Shelf File discounting.

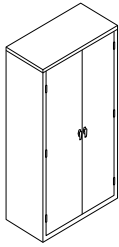

- ▶ Product shipped fully assembled.
- ▶ Stretch-wrap cartoning.
- ▶ Flush top.
- ▶ Two adjustable leveling glides standard.
- ▶ Reinforced base.
- ▶ One locking handle, one fixed handle.
- ▶ Adjustable shelves.
- ▶ Doors have vertical stiffener standard.
- ▶ Positive door stops.
- ▶ Shelf tested to 250 lbs.
- ▶ **Storage Cabinet available in Black (P), Charcoal (S), Light Gray (Q) and Putty (L) ONLY.**
- ▶ Equipped with HON "One Key" interchangeable core removable locks. Keyed alike cores must be ordered separately — see page 463.
- ▶ Meets or exceeds ANSI/BIFMA and ISTA standards.



ONE KEY Refer to page 463

Storage Cabinets

Description	Model	Ship Weight	Cube	List
36"W x 24 1/4"D x 71 3/4"H	IN STOCK SC2472	149	37.0	\$ 777
36"W x 18 1/4"D x 71 3/4"H	IN STOCK SC1872	131	35.1	\$ 667

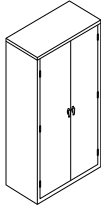

71 3/4" High

NOTE: Includes 5 adjustable shelves with clips.

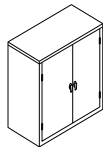

41 3/4" High

36"W x 18 1/4"D x 41 3/4"H	IN STOCK SC1842	82	20.8	\$ 562
----------------------------	------------------------	----	------	--------

NOTE: Includes 2 adjustable shelves with clips.

Additional Shelves

36"W x 24"D	AS24	8	0.7	\$ 87
36"W x 18"D	AS18	6	0.6	\$ 69

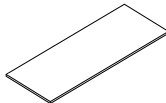

NOTE: Shelf clips included.

Conversion Kit

Hanging Bar and brackets to convert a Storage Cabinet into a Wardrobe Cabinet.	WC72	5	0.4	\$ 64
--	-------------	---	-----	-------

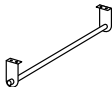

NOTE: **For use on SC Model Storage Cabinets shown above, only.**
Necessary hardware included to screw into shelf.
Does not work on ETA Storage Cabinets.



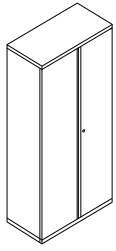

IN STOCK See page 1.
 Shippable by small-package carrier.

SPECIFY: Model.Paint

EXAMPLE: SC2472.P

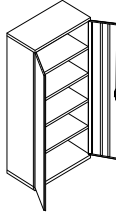
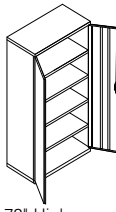

- ▶ All shelves are adjustable in 1¹³/₁₆" increments.
- ▶ Shelf tested to 180 lbs.
- ▶ Standard radius handle on right side of door.
- ▶ Lock is NOT core removable.
- ▶ **ETA Storage Cabinets available in Light Gray (Q) and Putty (L) ONLY.**
- ▶ Magnetic door clip standard to keep doors shut when in the unlocked position.
- ▶ **HON Limited 5-year Warranty.**
- ▶ Meets or exceeds ANSI/BIFMA and ISTA performance standards.

	Description	Model	Ship Weight	Cube	List
Storage Cabinets	36"W x 18"D x 78"H NOTE: Includes 4 adjustable shelves.	C187836	107	6.6	\$ 544
	E A				
78" High					
Storage Cabinets	36"W x 18"D x 72"H NOTE: Includes 4 adjustable shelves.	C187236	101	5.5	\$ 467
	E A				
72" High					
Storage Cabinets	36"W x 18"D 42 ³ / ₄ "H NOTE: Includes 2 adjustable shelves.	C184236	67	3.7	\$ 381
	E A				
42 ³ / ₄ " High					
Additional Shelf	36"W x 18"D x 1"H	CSH1836	10 	1.0	\$ 56
					

E A Easy to assemble.
 Shippable by small-package carrier.

SPECIFY: Model.Paint

EXAMPLE: C187836.L

index accessories education tables storage & files seating systems desking

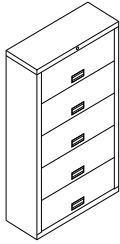

- ▶ **NEW!** Choice/Metallic and Custom paint options.
- ▶ See specifying information below for Choice/Metallic paint and pages 9 and 337 for Custom paint ordering instructions.
- ▶ 36" wide 5 and 6 fixed shelf files are offered in letter and legal depths, and in jumbo height in legal depth; locking models have one receding door per shelf.
- ▶ Shelf files accept letter or legal files side to side.
- ▶ Double wall construction provides extra strength.
- ▶ Receding door models operate on nylon glides installed in the door tracks.
- ▶ Two wire dividers per shelf are standard.
- ▶ Can be ganged back-to-back.
- ▶ Four adjustable leveling glides.
- ▶ Bright anodized aluminum recessed door pull/label holder on receding doors.
- ▶ Baked enamel finish over rust-inhibiting phosphate pre-treatment.
- ▶ Meets or exceeds ANSI/BIFMA and ISTA performance standards.
- ▶ Choose paint/color grades. See pages 336 and 337 for paint options.
- ▶ All receding door models are equipped with HON "One Key" interchangeable core removable locks operating two 16 gauge lock bars with tabs, which engage both sides of doors. Keyed alike cores must be ordered separately — see page 463.



ONE KEY Refer to page 463

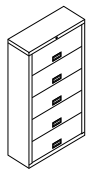

Description	Model	Ship Weight	Cube	List by Paint Grade		
				Choice/ Core	Metallics "2"	Custom "3"
5 Shelf Letter, lock, 64¼"H x 36"W x 13¾"D	625L	165	23.7	\$1075	\$1135	\$1195
5 Shelf Legal, lock, 64¼"H x 36"W x 16¾"D	625CL	170	28.2	\$1142	\$1202	\$1262
6 Shelf Letter, lock, 75⅞"H x 36"W x 13¾"D	IN STOCK 626L	178	27.8	\$1239	\$1299	\$1359
6 Shelf Legal, lock, 75⅞"H x 36"W x 16¾"D	IN STOCK 626CL	190	33.1	\$1313	\$1373	\$1433

NOTE: 10⅞"H between shelf and door. Shelves are not adjustable.

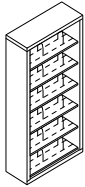

6 Shelf Letter, Open, 75⅞"H x 36"W x 13¾"D	IN STOCK 626N	145	27.8	\$ 773	\$ 833	\$ 893
6 Shelf Legal, Open, 75⅞"H x 36"W x 16¾"D	IN STOCK 626CN	160	33.1	\$ 845	\$ 905	\$ 965

NOTE: 10⅞"H between shelves. Shelves are not adjustable.

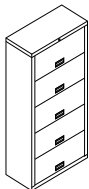

Jumbo 5 Shelf Legal, lock, 75⅞"H x 36"W x 16¾"D	J625CL	193	33.1	\$1276	\$1336	\$1396
---	---------------	-----	------	--------	--------	--------

NOTES: Use for 3-ring binders. 13"H between shelf and door. Shelves are not adjustable.

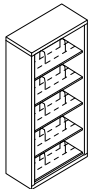

Jumbo 5 Shelf Legal, Open, 75⅞"H x 36"W x 16¾"D	J625CN	158	33.1	\$ 807	\$ 867	\$ 927
---	---------------	-----	------	--------	--------	--------

NOTE: 13¾"H between shelves. Use for 3-ring binders.

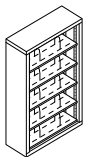

5 Shelf Letter, Adjustable Shelves, Open 58⅞"H x 36"W x 13¾"D	625AS	123	21.8	\$ 795	\$ 855	\$ 915
6 Shelf Letter, Adjustable Shelves, Open 69¾"H x 36"W x 13¾"D	626AS	143	25.7	\$ 903	\$ 963	\$1023

NOTE: Shelves are adjustable at 1⅜". Use all shelves for horizontal filing of 8¼"W materials. To store standard size binders, remove one shelf and adjust remaining shelves accordingly.



Dividers (12/pack)	517514	2.7	0.1	\$ 56
Wire Divider (6/pack)	860000	0.5	0.1	\$ 35

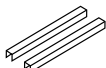

Depth Converter Legal-to-Letter (2/pack)	515700	5	0.5	\$ 67
---	---------------	---	-----	-------

IN STOCK See page 1.
 Shippable by small-package carrier.

SPECIFY: Model.Paint
 Model/Paint Grade "2".Paint

EXAMPLE: 625L.P
 625L2.T1

index accessories education tables storage & files seating systems desking

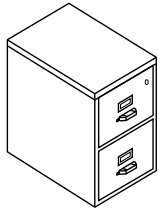

VERTICAL FILES

- ▶ Full suspension.
- ▶ Non-asbestos.
- ▶ Follower block standard (spring-loaded).
- ▶ Chrome drawer pulls, thumbblatch and label holder.
- ▶ Lock is NOT core removable.
- ▶ Rated: Filing Device Class 350, 1700° for one hour with drop test.
- ▶ UL listed.
- ▶ High drawer sides.
- ▶ Available in Putty, Black and Gray only; see page 336.
- ▶ Insulated in drawer face and between drawers.
- ▶ Lifetime Warranty.



Description	Model	Ship Weight	Cube	List
27¾"H x 17¾"W x 25"D 2-Drawer, Letter	52P	320	10	\$1923
27¾"H x 20¾"W x 25"D 2-Drawer, Legal	52CP	341	13	\$1974

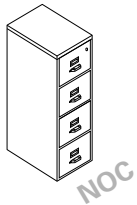

52¾"H x 17¾"W x 25"D 4-Drawer, Letter	54P	546	17	\$3008
52¾"H x 20¾"W x 25"D 4-Drawer, Legal	54CP	596	21	\$3070

GSA — Above models receive Open Market discounting.

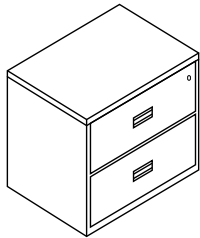

LATERAL FILES

- ▶ Telescoping suspension.
- ▶ Non-asbestos.
- ▶ Available in Putty, Black and Gray only; see page 336.
- ▶ Rated: Filing Device Class 350, 1700° for one hour with drop test.
- ▶ Insulated in drawer face and between drawers.
- ▶ UL listed.
- ▶ Lock is NOT core removable.
- ▶ 4 hangrails per opening, standard.
- ▶ Black, plastic recessed drawer pulls.
- ▶ Lifetime Warranty.



Description	Model	Ship Weight	Cube	List
27¾"H x 22½"D x 31½"W 2-Drawer, Lateral	32P	436	11	\$2837



52¾"H x 22½"D x 31½"W 4-Drawer, Lateral	34P	723	26	\$4343
--	------------	-----	----	--------

GSA — Above models receive Open Market discounting.

NOTE: Lateral Drawer inside dimensions:
10¾"H x 25¾"W x 15½"D

SPECIFY: Model.Paint

EXAMPLE: 52PP

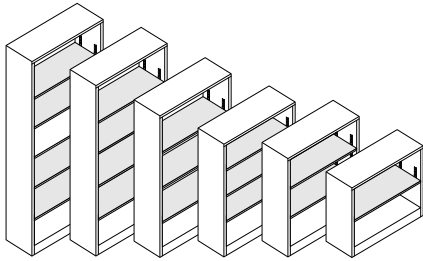

- ▶ **NEW!** Choice/Metallic and Custom paint options.
- ▶ See specifying information below for Choice/Metallic paint and pages 9 and 345 for Custom paint ordering instructions.
- ▶ Available in 2, 3, 4, 5, and 6 shelf models.
- ▶ Inside shelf depth is 12 $\frac{1}{8}$ ".
- ▶ Bookcase shelves easily adjust in $\frac{1}{2}$ " increments (shaded shelves are adjustable).
- ▶ Optional laminate tops available.
- ▶ Baked enamel finish over rust-inhibiting phosphate pre-treatment.
- ▶ Choose paint/color grades. See pages 336 and 337 for paint options.
- ▶ Meets or exceeds ANSI/BIFMA and ISTA performance standards.



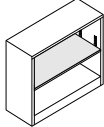

Description	Model	Ship Weight	Cube	List by Paint Grade		
				Core	Choice/Metallics "2"	Custom "3"
 34 $\frac{1}{2}$ "W x 12 $\frac{5}{8}$ "D x 29"H Bookcase, 2-Shelf	IN STOCK S30ABC	44	9.6	\$ 170	\$ 200	\$ 230
34 $\frac{1}{2}$ "W x 12 $\frac{5}{8}$ "D x 41"H Bookcase, 3-Shelf	IN STOCK S42ABC	57	13.3	\$ 204	\$ 234	\$ 264
34 $\frac{1}{2}$ "W x 12 $\frac{5}{8}$ "D x 47"H Bookcase, 4-Shelf	IN STOCK S48ABC	67	15.1	\$ 258	\$ 288	\$ 318
34 $\frac{1}{2}$ "W x 12 $\frac{5}{8}$ "D x 59"H Bookcase, 4-Shelf	IN STOCK S60ABC	77	18.9	\$ 309	\$ 369	\$ 429
34 $\frac{1}{2}$ "W x 12 $\frac{5}{8}$ "D x 71"H Bookcase, 5-Shelf	IN STOCK S72ABC	87	22.6	\$ 353	\$ 413	\$ 473
34 $\frac{1}{2}$ "W x 12 $\frac{5}{8}$ "D x 81 $\frac{1}{8}$ "H Bookcase, 6-Shelf	IN STOCK S82ABC	97	25.2	\$ 484	\$ 544	\$ 604

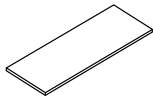
Shaded shelves are adjustable.

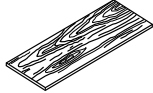

Extra Shelf for all Models	B9	7		0.3	\$ 48	\$ 58	\$ 68
----------------------------	-----------	---	---	-----	-------	-------	-------

NOTE: Edge is $\frac{3}{4}$ " thick. Specify: Paint

Description	Model	Ship Weight	Cube	List	
 Laminate Top for all Models Specify: Laminate	511596	16		0.7	\$ 155

IN STOCK See page 1.
 Shippable by small-package carrier.

**SPECIFY: Model.Paint
Model/Paint Grade "2".Paint**

**EXAMPLE: S30ABC.P
S30ABC2.T1**

10500 Series Laminate Bookcases

GSA SIN 711-8

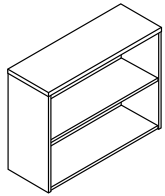

Square Corner Edge Detail

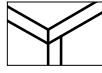

- ▶ 10500 Series Casegoods smooth, flat edge detail (see pages 120-134) and complements many other furniture designs.
- ▶ Fully finished back.
- ▶ Replaces 1980 Series Laminate Bookcases
- ▶ Bottom shelf, top and end panel are 1 1/8" thick. Interior shelves are 3/4" thick.
- ▶ All surfaces finished in abrasion- and stain-resistant thermal-fused laminate over solid core high-performance particleboard.
- ▶ Adjustable hex leveling glides allow floorstanding bookcases to be easily leveled without lifting the unit; glides have 3/4" adjustable range.
- ▶ Meets or exceeds ANSI/BIFMA and ISTA performance standards.

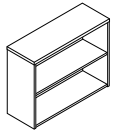

Description

Model

Ship Weight

Cube

List

36"W x 13 1/8"D x 29 5/8"H Bookcase, 2-Shelf	105532	90	11.0	\$ 327
36"W x 13 1/8"D x 43 3/8"H Bookcase, 3-Shelf	105533	122	15.6	\$ 423
36"W x 13 1/8"D x 57 1/8"H Bookcase, 4-Shelf	105534	156	20.3	\$ 499
36"W x 13 1/8"D x 71"H Bookcase, 5-Shelf	105535	187	25.4	\$ 599

NOTE: Preassembled with fixed shelves.

Inside shelf dimensions on all units is 33 1/16"W x 11 15/16"D x 12 15/16"H.

10500 Series Laminate Bookcases

▶ Available Laminate Colors:

Woodgrain: Bourbon Cherry (HH), Columbian Walnut (ZZ), Henna Cherry (JJ), Mahogany (NN), Medium Oak (MM), Natural Maple (DD) and Shaker Cherry (FF).

Solid: Black (PP) and Charcoal (SS).

Patterned Top:* Bronze Legacy (L3), Carbon Evolv (L1), Grey Tigris (L6).

*Patterned Laminates are available with the following chassis/edgebanding laminate selection: Black (P), Bourbon Cherry (H), Charcoal (S), Columbian Walnut (Z), Henna Cherry (J), Mahogany (N), Medium Oak (M), Natural Maple (D) and Shaker Cherry (F). Edgebanding around top will match chassis laminate color selected.

Two-tone (top/chassis): Top and edge banding are the same, chassis is different laminate color: Black/Charcoal (PS), Bourbon Cherry/Black (HP), Bourbon Cherry/Charcoal (HS), Charcoal/Black (SP),

Columbian Walnut/Black (ZP), Columbian Walnut/Charcoal (ZS), Henna Cherry/Black (JP), Henna Cherry/Charcoal (JS),

Mahogany/Black (NP), Mahogany/Charcoal (NS), Medium Oak/Black (MP), Medium Oak/Charcoal (MS),

Natural Maple/Black (DP), Natural Maple/Charcoal (DS), Shaker Cherry/Black (FP), Shaker Cherry/Charcoal (FS).

Patterned Top

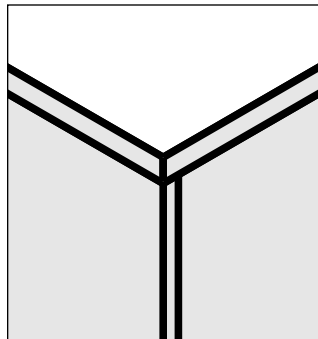
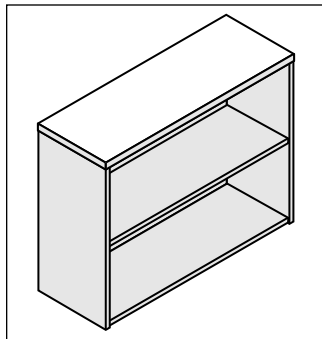

Edge Band Around Top / Laminate Base

Two-Tone Laminate Top / Edge Banding

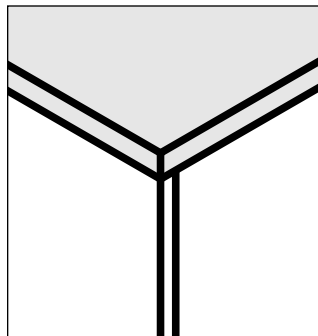
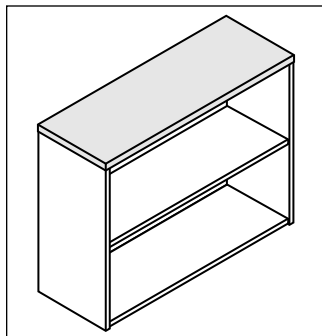

Laminate Base

SPECIFY: Model.Laminate

EXAMPLE: 105532.NN

GSA SIN 711-8

1870 Series Laminate Bookcases

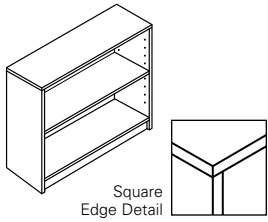

- ▶ Square edge profile complements many different furniture designs.
- ▶ Intended for small office-home office applications.
- ▶ Thermal-fused laminate, over durable solid core, high-performance particleboard, is abrasion- and stain-resistant.

- ▶ ¾" thick shelves adjust in 1¼" increments to suit a variety of storage needs (two shelves are fixed in 5- and 6-shelf units).
- ▶ Cam-lock fasteners and wood dowels ensure pieces go together easily and precisely.
- ▶ Equipped with four adjustable leveling glides.
- ▶ Shelves will deflect under large amounts of weight.

- ▶ ½" hardboard back panel.
- ▶ All bookcases are 36"W x 11½"D.
- ▶ Extra shelves available as an option.
- ▶ Optional doors available to conceal lower shelf contents.
- ▶ Choose from Medium Oak, Mahogany or Henna Cherry.

- ▶ Easy-to-assemble instructions included.
- ▶ Meets or exceeds ANSI/BIFMA and ISTA performance standards.

	Description	Model	Ship Weight	Cube	List
	36"W x 11½"D x 29⅞"H Bookcase, 2-Shelf	IN STOCK 1871	48	1.5	\$ 178
	36"W x 11½"D x 36⅞"H Bookcase, 3-Shelf	IN STOCK 1872	60	1.7	\$ 198
	36"W x 11½"D x 48¾"H Bookcase, 4-Shelf	IN STOCK 1874	77	2.6	\$ 240
	36"W x 11½"D x 60⅞"H Bookcase, 5-Shelf	IN STOCK 1875	92	2.8	\$ 284
	36"W x 11½"D x 72⅞"H Bookcase, 6-Shelf	IN STOCK 1876	109	3.4	\$ 327
	36"W x 11½"D x 84"H Bookcase, 6-Shelf	IN STOCK 1877	124	4.5	\$ 373
	Set of doors 36"W x 25¾"H with hinges used to conceal lower shelf contents	1801	23	1.0	\$ 143
	Extra shelf for all models 34¼"W x 11⅞"D x ¾" thick	1802	11	0.9	\$ 81

SPECIFY: Model.Laminate

EXAMPLE: 1871.N

GSA SIN 711-8

1890 Series Laminate Bookcases

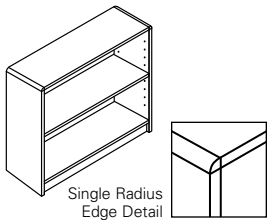

- ▶ Tops feature radius trim made of attractive hardwood – complements many furniture designs.
- ▶ Intended for small office-home office applications.
- ▶ Thermal-fused laminate, over durable solid core, high-performance particleboard, is abrasion- and stain-resistant.

- ▶ ¾" thick shelves adjust in 1¼" increments to suit a variety of storage needs (two shelves are fixed in 5- and 6-shelf units).
- ▶ Cam-lock fasteners and wood dowels ensure pieces go together easily and precisely.
- ▶ Equipped with four adjustable leveling glides.
- ▶ Shelves will deflect under large amounts of weight.

- ▶ ½" hardboard back panel.
- ▶ All bookcases are 36"W x 11½"D.
- ▶ Extra shelves available as an option.
- ▶ Optional doors available to conceal lower shelf contents.
- ▶ Choose from Medium Oak, Mahogany or Henna Cherry.

- ▶ Easy-to-assemble instructions included.
- ▶ Meets or exceeds ANSI/BIFMA and ISTA performance standards.

	Description	Model	Ship Weight	Cube	List
	36"W x 11½"D x 29⅞"H Bookcase, 2-Shelf	1891	48	1.5	\$ 200
	36"W x 11½"D x 36⅞"H Bookcase, 3-Shelf	1892	60	1.7	\$ 220
	36"W x 11½"D x 48¾"H Bookcase, 4-Shelf	1894	77	2.6	\$ 262
	36"W x 11½"D x 60⅞"H Bookcase, 5-Shelf	1895	92	2.8	\$ 306
	36"W x 11½"D x 72⅞"H Bookcase, 6-Shelf	1896	109	3.4	\$ 349
	36"W x 11½"D x 84"H Bookcase, 6-Shelf	1897	124	4.5	\$ 395
	Set of doors 36"W x 25¾"H with hinges used to conceal lower shelf contents	1801	23	1.0	\$ 143
	Extra shelf for all models 34¼"W x 11⅞"D x ¾" thick	1802	11	0.9	\$ 81

SPECIFY: Model.Laminate

EXAMPLE: 1891.N

IN STOCK See page 1.
 Easy to assemble.
 Shippable by small-package carrier.